

Everywhere, that's where I want to go



# PRODUCTS 2025 CATALOGUE

For motorhomes, caravans, van conversions and campervans

[fiamma.com](https://fiamma.com)



# Quality and technology on the road for 80 years



Founded in Italy in 1945, Fiamma is an international leader in the development of technical accessories to convert your vehicle into the ideal vehicle for every adventure. Its products offer you technology and quality without boundaries.

## Fiamma.com

Here you will find the technical data sheets of the products, the list of recommended dealers and the 53 trade fairs where you can visit the Fiamma stand.

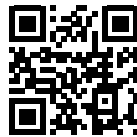

## Certifications





Travelling on board a motorhome is the best way to get to know the world. In absolute freedom, you can decide when to leave and where to stop. With friends or family, by the sea or at the foot of a mountain, you can imagine the trip you want, if your vehicle has Fiamma products.

The quality of each item, tested in the laboratory and then on the road, along with professional assistance always available will make every trip an unforgettable moment of dolce vita.



## Fiamma



**1**  
logistics and  
design centre



**100,000**  
spare parts in stock



**5**  
production units



**100**  
patents

## Warranty extension



For awnings and Carry-Bike it is possible to extend the warranty for one year, free of charge, with Fiamma Care, by registering in the reserved area of the site and registering the product with the relevant proof of purchase.







CITROËN

F1AMMA

PEAK



## FIAMMASTORE

---

<b>Awnings</b>	8	<b>Panels and enclosures</b>	70
Winch awnings for wall installation	12	Fronts and Sides	72
Winch awnings for roof installation	22	Enclosures	82
Manual awnings	32	Complete tents (awning + enclosure)	96
Motor-Kit	38	Roof tent	98
Awning accessories	40	Rear door enclosures	102
Adapters	46	Skirting for wind protection	103
		Enclosure accessories	104

## CARRY-BIKE

---

<b>Bike carriers</b>	108
Motorhome	114
Caravan	122
Campervan	128
Van conversion	140
SUV	147
Garage	148
Accessories	152
Rear Boxes	157

## COMFORT

---

<b>Comfort</b>	160
Rooflights	162
Lighting	172
Water	178
Level systems	182
Organisation	186
Safety	196
Ladders	200
Hygiene	206
Vehicle covers	208
Miscellaneous	210



## **FIAMMASTORE**

With Fiamma, home is wherever you decide to go. Get on board of your vehicle and discover the world! Fiammastore products are the ideal travel companions for your holidays, trips, excursions and adventures. Whatever vehicle you have, in just a few moments you can enlarge the space at your disposal and transform it into an environment that you will immediately call "home".

Awnings, Blockers and Privacy Rooms make you feel protected wherever you decide to stop. Start planning your next trip: with Fiamma, "home is everywhere".

# The world is your home



### AWNINGS

Practical, easy to use and indispensable on sunny days.



### PANELS

You can mount them on the side or on the front: robust and effective, they are the smartest way to transform your vehicle.



### ENCLOSURES

Spacious and comfortable, they create a welcoming and safe space.



### ACCESSORIES

Customise each solution with the Fiamma accessory that best suits your needs.



AWNINGS



**Live  
in the open air  
comfortably**



**Fiamma awnings are the ideal complement for every lover of outdoor life. We have designed them to be easy to install, practical and able to protect you during your relaxing moments from the sun.**

**Simple, robust and essential in design, you can customise them according to your preferences with numerous accessories and they are suitable for mounting on any type of vehicle.**



**WALL INSTALLATION**

It is the most used type, because the wide range of brackets makes it compatible with most vehicles.



**ROOF INSTALLATION**

Extremely compact, it is installed on the roof of the vehicle thanks to special brackets, integrating perfectly with the aesthetics.



**RAIL MOUNTING**

Lightweight and easy to remove in a single motion, it uses the caravan's rail without the need for any brackets.



# Selection guide

How to choose the right awning for you? Here are some practical tips to help you make the right choice.

- Check if there are dedicated Fiamma solutions for your vehicle (Ducato, VW T5 & T6, PSA)
- Choose the awning according to your vehicle, its characteristics and your needs
- Check the usable space available for mounting the awning (wall or roof)
- Choose the bracket for your vehicle (you can find them in the special section of the catalogue from page 46)

## WINCH AWNINGS - WALL INSTALLATION



**F45s**



**F45L**



**F43van**

Installation	wall installation	wall installation	wall installation
Vehicle			
Length	190-450	450-550	270-300
Motor	optional motor	optional motor	-
Case box finishes	Polar White Titanium Deep Black	Polar White Titanium Deep Black	Deep Black

## WINCH AWNINGS - ROOF INSTALLATION



**F80s**



**F80L**



**F40van**

Installation	roof installation	roof installation	roof installation
Vehicle			
Length	290-450	450-600	210-270
Motor	optional motor	optional motor	-
Case box finishes	Polar White Titanium Deep Black	Polar White Titanium Deep Black	Deep Black

**AUTOMATIC - WALL / ROOF INSTALLATION**



**F45eagle**

wall installation



350-450

motorised



Polar White



**F65eagle**

roof installation



319-400

motorised



Polar White



Titanium

**MANUAL - WALL / ROOF / RAIL INSTALLATION**



**CaravanStore / XL**

rail mounting



190-550

-



Grey



**F35pro**

wall / roof / rail mounting



180-300

-



Titanium



Deep Black



**Compass**

wall installation



220-260

-



Silver



Black





# F45s

SUITABLE FOR MOTORHOMES, CARAVANS, VAN CONVERSIONS AND CAMPERVANS



The original wall-mounted awning, practical, robust, functional and versatile, it is the best value for money.

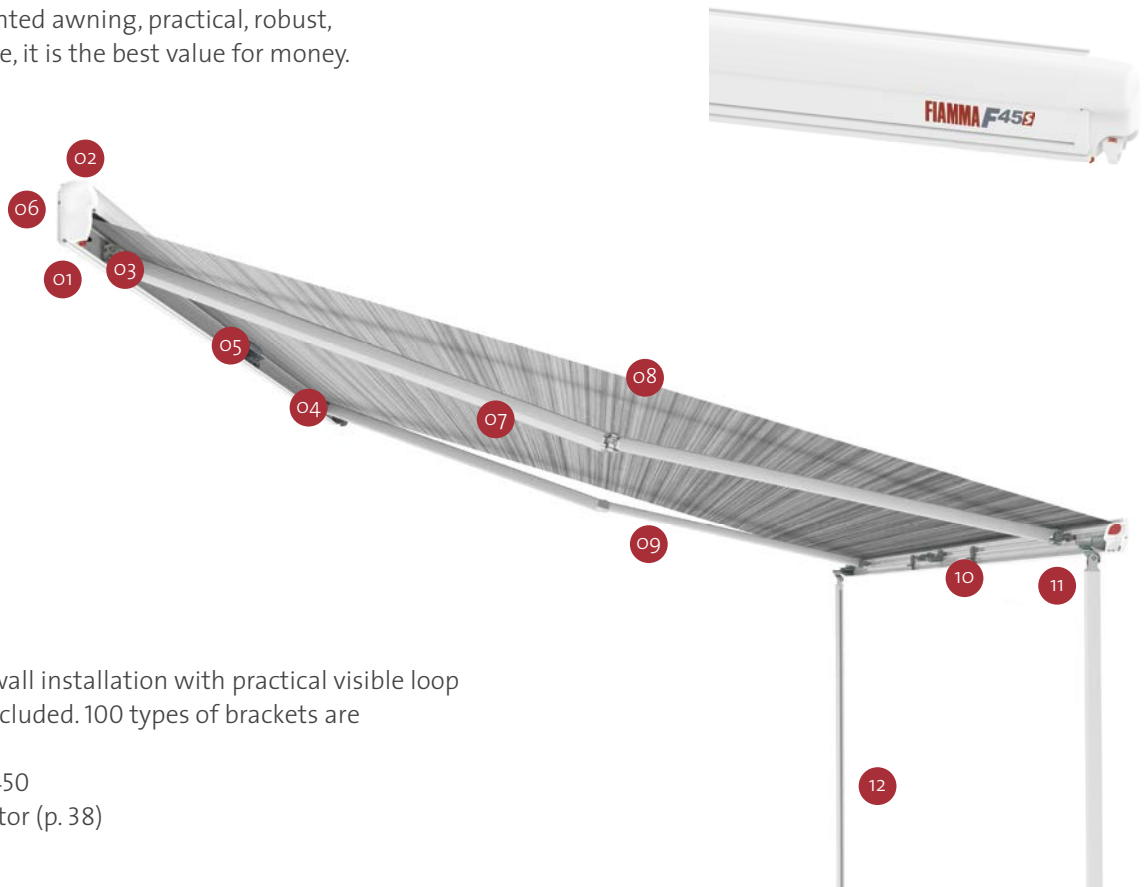

**FEATURES:**

- Winch awnings for wall installation with practical visible loop
- Standard brackets included. 100 types of brackets are optionally available
- Length from 190 to 450
- Optional electric motor (p. 38)
- Lightweight

- |   |   |  |   |
|---|---|--|---|
| <p><b>01 Visible loop</b><br/>For maximum ease of use</p>   | <p><b>02 Brackets</b><br/>To find brackets and adapters for every type of vehicle (p. 46)</p> | <p><b>03 Presto Fix</b><br/>Guarantees perfect closure of the lead bar over time</p> | <p><b>04 Dual Shock-Absorber</b><br/>Absorbs shocks in case of heavy stress</p> |
| <p><b>05 Roller support</b><br/>Facilitates the rolling up of the fabric</p>  | <p><b>06 Dual Security</b><br/>Indicator for correct closure of the lead bar</p>              | <p><b>07 Reinforced arms</b><br/>Keep the fabric tensioned</p>                       | <p><b>08 One Way Roll</b><br/>Guide the rolling direction of the fabric</p>     |
| <p><b>09 LEDs</b><br/>The cable ducts on the arms allow the passage of cables for the optional Fiamma LED kits (p. 172)</p> | <p><b>10 Double guide</b><br/>To install a front panel or Privacy and other accessories</p>   | <p><b>11 Telescopic Leg</b><br/>Equipped with a reinforced joint</p>                 | <p><b>12 Secure Lock</b><br/>Adjusts the height of the lead bar</p>             |





- + WHAT YOU CAN ADD TO YOUR FIAMMA F45s**
- |                             |                         |                       |                              |
|-----------------------------|-------------------------|-----------------------|------------------------------|
| Enclosures<br>- See page 82 | Panels<br>- See page 72 | LED<br>- See page 172 | Accessories<br>- See page 40 |
|-----------------------------|-------------------------|-----------------------|------------------------------|

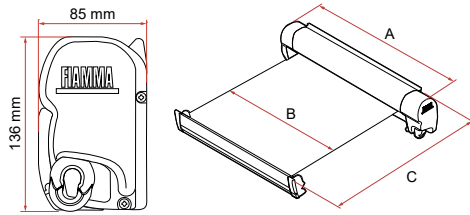



MODELS AND DIMENSIONS



CASE BOX

-  Polar White
-  Titanium
-  Deep Black

FABRIC

-  Royal Grey
-  Royal Pine
-  Royal Blue
-  Royal Caramel

F45s	Length A	Length B	Extension C	Shade Surface	Weight	Fabric colours	Item No. Polar White***	Item No. Titanium	Item No. Deep Black
190 *	185cm	169cm	100cm	1,7m <sup>2</sup>	11,5kg	R-Q	06280M01(X)	06290M01(X)	06759M01R
230	231cm	214cm	150cm	3,2m <sup>2</sup>	16,5kg		06280P01(X)	06290P01(X)	06759P01R
260	263cm	247cm	200cm	4,9m <sup>2</sup>	19,5kg		06280H01(X)	06290H01(X)	06759H01R
300	308cm	292cm		7,3m <sup>2</sup>	23,0kg		06280A01(X)	06290A01(X)	06759A01R
325	323cm	307cm		7,7m <sup>2</sup>	24,0kg		-	-	06759U01R
350	348cm	331cm		8,3m <sup>2</sup>	25,0kg		06280B01(X)	06290B01(X)	06759B01R
375	375cm	357cm	250cm	8,9m <sup>2</sup>	26,0kg		06280S01(X)	06290S01(X)	06759S01R
400 **	398cm	381cm		9,5m <sup>2</sup>	27,0kg		06280C01(X)	06290C01(X)	06759C01R
425 **	423cm	405cm		10,1m <sup>2</sup>	28,2kg		06280Q01(X)	06290Q01(X)	06759Q01R
450 **	448cm	431cm		10,8m <sup>2</sup>	29,5kg		06280G01(X)	06290G01(X)	06759G01R

The awning is delivered as standard with installation kit. \* Awning for the main door, comes without vertical support legs. \*\* 1 Tension Rafter made of anodized aluminium included. \*\*\*Ask your local dealer for availability and timing of the Royal Caramel (M) and Royal Pine (L) fabric versions. Specify the fabric colour you want when ordering by replacing (X) with: R=Royal Grey, Q=Royal Blue. For RHD vehicles available on request the left version awning with winch installed on the left side, case in Polar White and canopy in Royal Grey.







# F45s campervan

SUITABLE FOR CAMPERVANS



These special versions of our F45 awning are complete with an installation kit and are suitable for many types of minivan:

- VW T5 / T6 / T6.1
- PSA group

VW version also suitable for short and long wheelbase Multivan (Volkswagen transporter with C-rail) and California. PSA version also for lift roof models.

**FEATURES:**

- Winch awnings for wall installation with practical visible loop
- Specific brackets included
- Lengths 260 and 300 (only for VW T5 / T6)
- Optional electric motor (p. 38)



**CHOOSE THE AWNING ACCORDING TO YOUR VEHICLE**

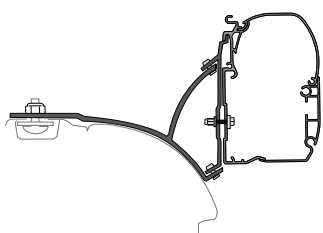

**F45s VW T5 / T6**



C rail Volkswagen

Model		Short wheelbase	Long wheelbase
VW T5 / T6 without C rail	Awning	F45s 260 standard **	-
	Adapter	optional ***	-
VW T5 / T6 with C rail	Awning	F45s 260 VW T5/T6 *	F45s 300 VW T5/T6 *
	Adapter	included in the awning	included in the awning
VW T5 / T6 California	Awning	F45s 260 VW T5/T6 *	-
	Adapter	included in the awning	-
VW T5 / T6 with Multirail Reimo	Awning	F45s 260 standard **	-
	Adapter	optional ***	-
VW T5 / T6 with Top-rail Brandrup	Awning	F45s 260 standard **	-
	Adapter	optional ***	-

\* F45s 260 / 300 VW T5 / T6 complete with installation kit dedicated to VW vans

\*\* see p. 12

\*\*\* see p. 56-57

**CHOOSE THE AWNING ACCORDING TO YOUR VEHICLE**

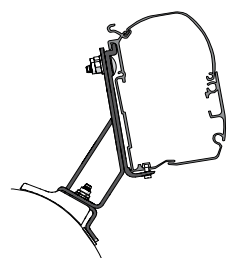

**F45s PSA**

Brand	Model	Year	Height - H1	Vehicle length	F45s PSA
Citroën	Jumpy III	> 2016	1895mm	4959mm	<b>F45s 260 PSA</b> complete with installation kit dedicated to PSA group camper vans
	Spacetourer		1890mm	4956mm	
Opel / Vauxhall	Vivaro C	> 2019	1881/1940mm	4959mm	
	Zafira Life		1890/1930mm	4956mm	
Peugeot	Expert III	> 2016	1881/1940mm	4959mm	
	Traveller		1881/1980mm		
Toyota	Proace II		1899/1940mm		
	Proace Verso		1899mm		

**MODELS AND DIMENSIONS**

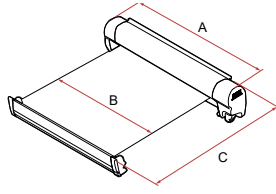
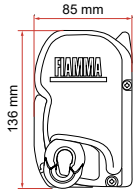

F45s VW T5 / T6	Length A	Length B	Extension C	Shade Surface	Weight	Item No. Polar White	Item No. Titanium	Item No. Deep Black
260 - VW T5 / T6 <b>C</b>						06280E01R	06290E01R	06759E01R
260 - VW T5 / T6 <b>M / T</b>	263cm	247cm		4,9m <sup>2</sup>	19,5kg	-	06290D01R	06759D01R
260 - VW T5 / T6 <b>M / T - RHD</b>			200cm	7,3m <sup>2</sup>	23,0kg	-	06291D01R	07129D01R
300 - VW T5 / T6 <b>M / T - Long</b>				7,3m <sup>2</sup>	23,0kg	-	06290R01R	06759R01R
300 - VW T5 / T6 <b>M / T - Long - RHD</b>	308cm	292cm		7,3m <sup>2</sup>	23,0kg	-	06291R01R	07129R01R

**M:** Multivan - **T:** Transporter - **C:** California  
Long = long wheel base

F45s PSA	Length A	Length B	Extension C	Shade Surface	Weight	Item No. Polar White	Item No. Deep Black
260	263cm	247cm	200cm	4,9 m <sup>2</sup>	19,5kg	06280F01R	06759F01R

**WHAT YOU CAN ADD TO YOUR FIAMMA F45S CAMPERVAN**

- Enclosures - See page 82
- Panels - See page 72
- LED - See page 172
- Accessories - See page 40

**CASE BOX**

- Polar White
- Titanium
- Deep Black

**FABRIC**

- Royal Grey







# F43van

SUITABLE FOR CAMPERVANS



Wall-mounted winch awning, specifically designed for campervans. Compact and innovative design, it perfectly matches the shape and aesthetics of campervans, even those with pop-up roofs.



**FEATURES:**

- Opening via winch with magnetic catch which is concealed in the cover, conveniently positioned due to the awning's mounting height on the van
- Awning opening with negative inclination to use the space at full height (max. 2.20 m)
- LED provision in the case box, recessed front closure
- The compact shape of the awning once installed reduces the maximum height from the ground, granting access to parking spaces
- Lengths 270 and 300

**01 Magnetic attachment**  
For opening the awning, concealed in the cap cover

**02 Brackets**  
Standard bracket included, can be combined with vehicle-specific brackets (p. 46)

**03 Arms**  
Reinforced and with reduced cross-section

**04 One Way Roll**  
Guide the rolling direction of the fabric

**05 LED preparation**  
Integrated in the box, to illuminate the space (p. 172)

**06 Guides**  
Concealed, for installation of the Room Van Premium or other accessories

**+ AWNING INCLINATION**

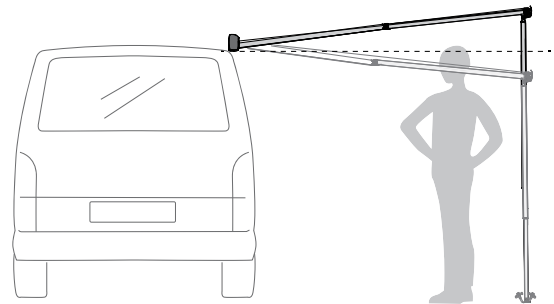

**07 Telescopic Leg**  
Equipped with a reinforced joint

**08 Secure Lock**  
Adjusts the height of the lead bar

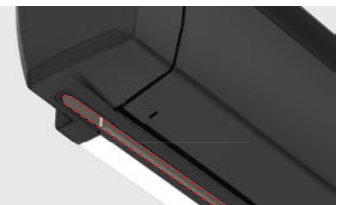
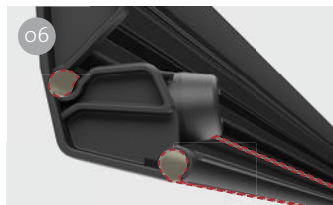
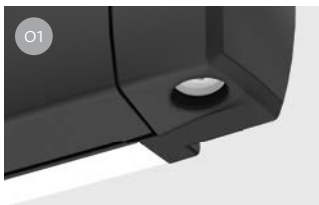

MODELS AND DIMENSIONS

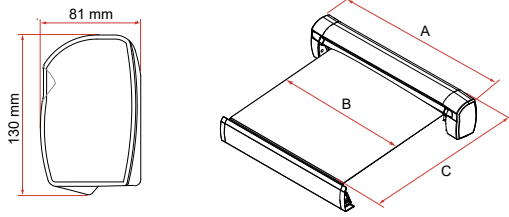

F43van	Length A	Length B	Extension C	Shade Surface	Weight	Item No.
270	270cm	257cm	225cm	6,9m <sup>2</sup>	19,0kg	08833A01R
300	310cm	287cm	250cm	8,9m <sup>2</sup>	21,5kg	08833B01R

CASE BOX

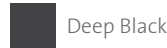

FABRIC



OPTIONAL - RAFTER LED VAN

Rafter for an optimally stretched fabric. It guarantees greater wind resistance and prevents the formation of water pockets in the event of rain, thanks to its installation perpendicular to the arms of the awning. It comes with LEDs to illuminate your holiday space.



WHAT YOU CAN ADD TO YOUR FIAMMA F43VAN

- Enclosures  
- See page 82
- Panels  
- See page 72
- LED  
- See page 172
- Accessories  
- See page 40







# F45L

SUITABLE FOR MOTORHOMES AND VAN CONVERSIONS



This special wall-mounted awning with oversized components and an extra-large roller is suitable for large vehicles and therefore provides a large area of shade for the whole family.



**FEATURES:**

- Winch awnings for wall installation with practical visible loop
- Standard brackets included. 100 types of brackets are optionally available
- Length from 450 to 550
- Optional electric motor (p. 38)

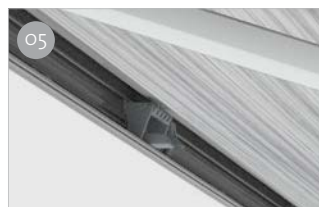

- |   |   |  |   |
|---|---|--|---|
| <p><b>01 Visible loop</b><br/>For maximum ease of use</p>   | <p><b>02 Brackets</b><br/>To find brackets and adapters for every type of vehicle (p. 46)</p> | <p><b>03 Presto Fix</b><br/>Guarantees perfect closure of the lead bar over time</p> | <p><b>04 Dual Shock-Absorber</b><br/>Absorbs shocks in case of heavy stress</p> |
| <p><b>05 Roller support</b><br/>Facilitates the rolling up of the fabric</p>  | <p><b>06 Dual Security</b><br/>Indicator for correct closure of the lead bar</p>              | <p><b>07 Reinforced arms</b><br/>Keep the fabric tensioned</p>                       | <p><b>08 One Way Roll</b><br/>Guide the rolling direction of the fabric</p>     |
| <p><b>09 LEDs</b><br/>The cable ducts on the arms allow the passage of cables for the optional Fiamma LED kits (p. 172)</p> | <p><b>10 Double guide</b><br/>To install a front panel or Privacy and other accessories</p>   | <p><b>11 Telescopic Leg</b><br/>Equipped with a reinforced joint</p>                 | <p><b>12 Secure Lock</b><br/>Adjusts the height of the lead bar</p>             |



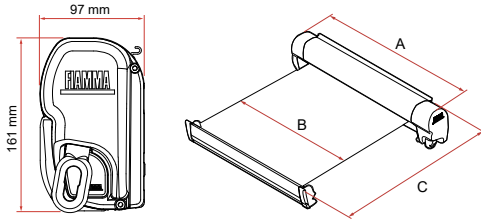



MODELS AND DIMENSIONS



CASE BOX

-  Polar White
-  Titanium
-  Deep Black

FABRIC

-  Royal Grey
-  Royal Blue
-  Royal Pine
-  Royal Caramel

F45L	Length A	Length B	Extension C	Shade Surface	Weight	Fabric colours	Item No. Polar White*	Item No. Titanium	Item No. Deep Black
450	452cm	435cm		10,9m <sup>2</sup>	39,0kg		06530-01(X)	06532-01(X)	06533-01R
500	502cm	485cm	250cm	12m <sup>2</sup>	42,5kg	R-Q	06530A01(X)	06532A01(X)	06533A01R
550	552cm	535cm		13,3m <sup>2</sup>	46,5kg		06530B01(X)	06532B01(X)	06533B01R

Specify the fabric colour you want when ordering by replacing (X) with: R=Royal Grey, Q=Royal Blue.  
 \*Ask your local dealer for availability and timing of the Royal Caramel (M), Royal Pine (L) fabric versions.

WHAT YOU CAN ADD TO YOUR FIAMMA F45L

- Enclosures - See page 82
- Panels - See page 72
- LED - See page 172
- Accessories - See page 40







# F45eagle

SUITABLE FOR MOTORHOMES



Automatic motorised awning, without support legs, with self-supporting arms.

Motorised with compact motor, characterised by small size, simple construction, reliability and excellent performance. Operated using the wall-mounted Control System.

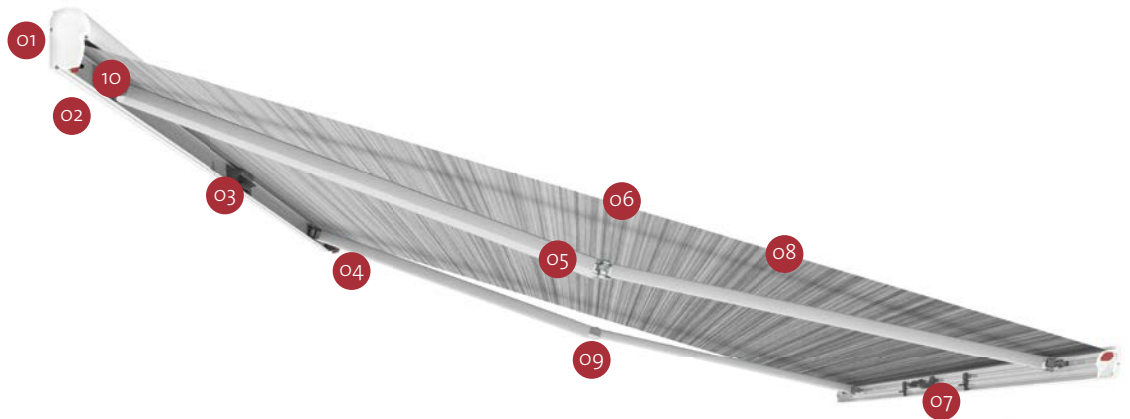

**FEATURES:**

- Motorised
- Self-supporting arms
- Length: from 350 to 450
- Standard adapter included

**01 Brackets**

Full length adapter supplied as standard

**02 Presto Fix**

Guarantees perfect closure of the lead bar over time

**03 Roller support**

Facilitates the rolling up of the fabric

**04 12V motor included**

To operate the awning in one easy step

**05 Reinforced arms**

Keep the fabric tensioned

**06 One Way Roll**

Guide the rolling direction of the fabric

**07 Double guide**

To install a front panel and other accessories

**08 Wind Detection System**

Sensor that is automatically activated and closes the awning in case of strong wind

**09 LEDs**

The cable ducts on the arms allow the passage of cables for the optional Fiamma LED kits (page 172)

**10 Double Block support**

Allows the regulation of the inclination from 5° to 17° and reinforces the self-supporting arms, thus avoiding the use of support legs



☰ MODELS AND DIMENSIONS

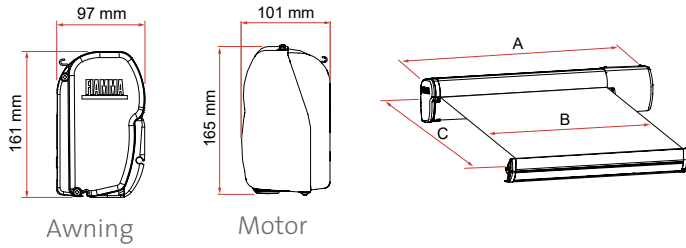

☰ CASE BOX



☰ FABRIC

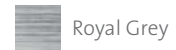

F45eagle	Length A	Length B	Extension C	Shade Surface	Weight	Item No.
350	366cm	335cm		8,3m <sup>2</sup>	33,5kg	08590-01R
400	416cm	385cm	250cm	9,6m <sup>2</sup>	36,5kg	08590A01R
450	466cm	435cm		11m <sup>2</sup>	39,5kg	08590B01R

Important: verify with your trusted dealer if your motorhome or motorcaravan is suitable for the installation of the F45eagle with sturdy full length aluminium bracket. The vehicle must be robust enough to support the weight and the tension of the open awning. Fiamma refuses all responsibility for damages to the walls or for water ingress due to incorrect installation or due to installations on weak walls.

+ WHAT YOU CAN ADD TO YOUR FIAMMA F45EAGLE

- LED - See page 172
- Accessories - See page 40







# F80s

SUITABLE FOR MOTORHOMES, CARAVANS AND VAN CONVERSIONS



The strengths of this awning are the triple guide on the front and the double LED arrangement. Elegant and minimalist in design, it blends in perfectly with the vehicle's silhouette.

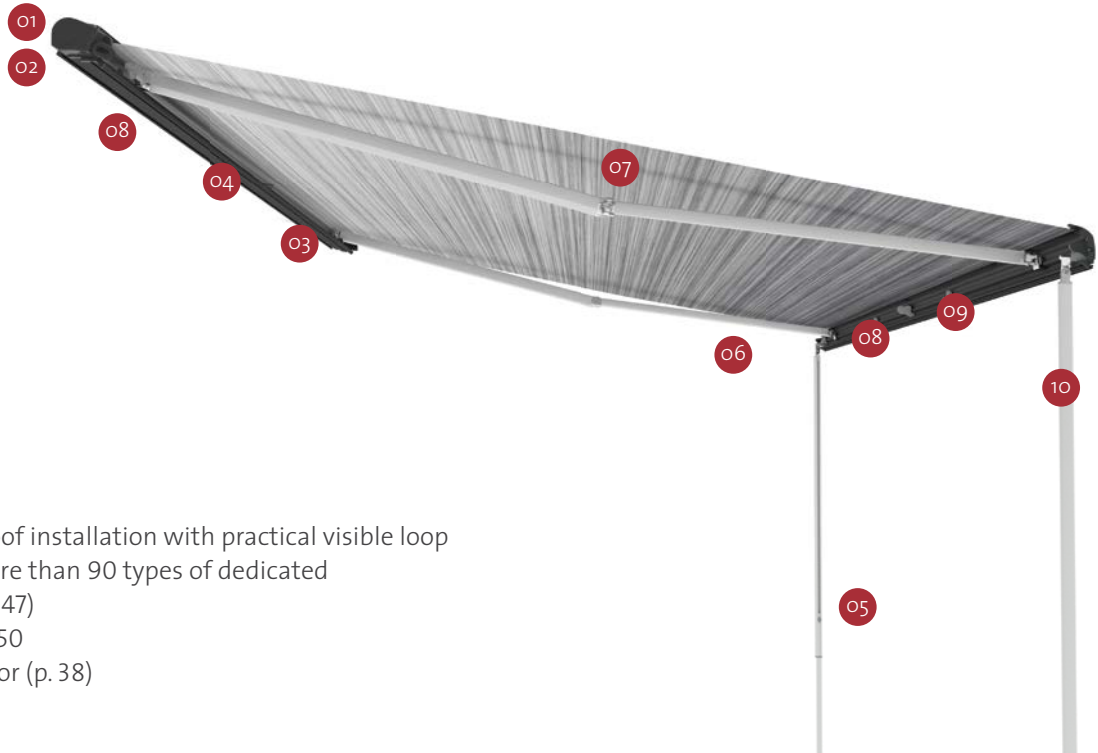

**FEATURES:**

- Winch awnings for roof installation with practical visible loop
- Brackets optional, more than 90 types of dedicated adapters available (p. 47)
- Length from 290 to 450
- Optional electric motor (p. 38)

**01 Visible loop**  
For maximum ease of use

**02 Brackets**  
Find brackets and adapters for every type of vehicle (p. 47)

**03 Dual Shock-Absorber**  
Absorbs shocks in case of heavy stress

**04 Roller support**  
Facilitates the rolling up of the fabric

**05 Secure Lock**  
Adjusts the height of the lead bar

**06 Arms**  
With provision to accommodate the Telescopic Rafter Arm Kit (p. 40)

**07 One Way Roll**  
Guide the rolling direction of the fabric

**08 Double LED preparation**  
Front and case box, LED light visible even when the awning is closed (p. 172)

**09 Triple guide**  
To install a front panel or Privacy and other accessories

**10 Telescopic Leg**  
Equipped with a reinforced joint

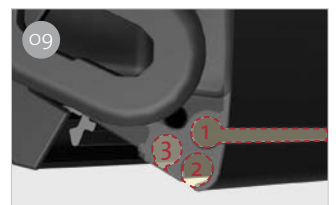

**MODELS AND DIMENSIONS**

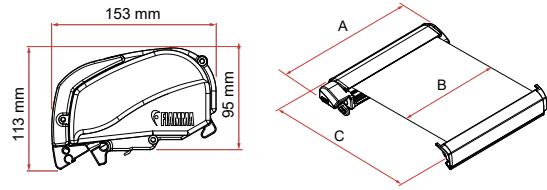

F80s	Length A	Length B	Extension C	Shade Surface	Weight	Item No. Polar White	Item No. Titanium	Item No. Deep Black
290	290cm	278cm	200cm	5,6m <sup>2</sup>	27,0kg	07830A01(X)	07832A01(X)	07831A01R
320	320cm	308cm	250cm	7,7m <sup>2</sup>	29,0kg	07830B03(X)	07832B03(X)	07831B03R
340	340cm	328cm		8,2m <sup>2</sup>	30,0kg	07830C03(X)	07832C03(X)	07831C03R
370	370cm	358cm		9,0m <sup>2</sup>	32,0kg	07830D03(X)	07832D03(X)	07831D03R
400 *	400cm	388cm		9,7m <sup>2</sup>	34,0kg	07830E03(X)	07832E03(X)	07831E03R
425 *	425cm	412cm		10,3m <sup>2</sup>	35,0kg	07830F03(X)	07832F03(X)	07831F03R
450 *	450cm	431cm		10,8m <sup>2</sup>	36,5kg	07830G03(X)	07832G03(X)	07831G03R

\* 1 Tension Rafter made of anodized aluminium included.  
Specify the fabric colour you want when ordering by replacing (X) with: R=Royal Grey, Q=Royal Blue

**+ OPTIONAL - KIT TELESCOPIC RAFTER ARM**

Optional accessory that can be installed on the F80s (from length 320) awnings to guarantee maximum stability. It prevents the arms from closing, whatever the weather conditions\*, guaranteeing resistance even under heavy stress.



\* however, conscientious use is recommended, avoiding exposure to the risk of weather events for which a weather alert has been issued by the appropriate authorities.

**+ WHAT YOU CAN ADD TO YOUR FIAMMA F80S**

- Enclosures  
- See page 82
- Panels  
- See page 72
- LED  
- See page 172
- Accessories  
- See page 40







# F80s Ducato

SUITABLE FOR VAN CONVERSIONS



Specific version of awning F80s for Ducato in lengths 320, 370 and 400 with Deep Black finish, complete with brackets, gasket and cover.



**FEATURES:**

- Winch awnings for roof installation with practical visible loop
- Specific brackets included, black finish - Kit Ducato / Citroën Jumper / Peugeot Boxer - Low Profile ≥ 2006 - H2 - L2 / L3 / L4
- Kit Rain Guard Slim (replacing the Rain Guard), a seal that prevents water from running down the wall of the vehicle
- Kit Cover, covers for greater integration of the awning with the vehicle profile
- Length from 320 to 400
- Optional electric motor (p. 38)

Kit Rain Guard Slim

Kit Cover F80s Ducato

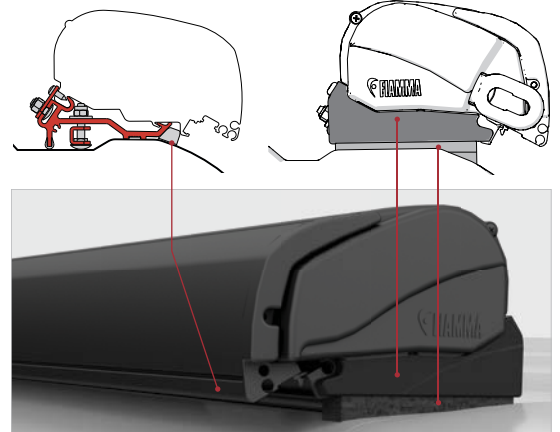

**MODELS AND DIMENSIONS**

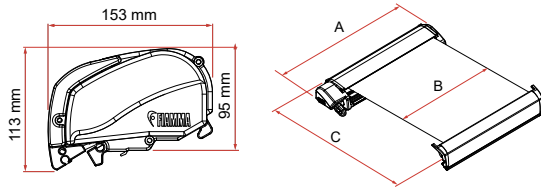

**CASE BOX**

- Polar White
- Deep Black

**FABRIC**

- Royal Grey

F80s Ducato	Length A	Length B	Extension C	Shade Surface	Weight	Item No. Polar White	Item No. Deep Black
320	320cm	308cm		7,7m <sup>2</sup>	29,0kg	07830N03R <b>[New]</b>	07831N03R
370	370cm	358cm	250cm	9,0m <sup>2</sup>	32,0kg	07830P03R <b>[New]</b>	07831P03R
400	400cm	388cm		9,7m <sup>2</sup>	34,0kg	07830Q03R <b>[New]</b>	07831Q03R

Delivered as standard with installation kit, gasket and cover

**COMPATIBLE VEHICLES**

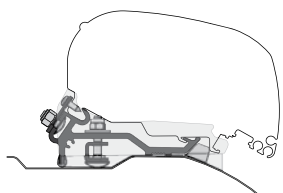

Brand	Model	Year	Height H2	Vehicle Length L2 F80 320	Vehicle Length L3 F80 370	Vehicle Length L4 F80 400
Fiat	Ducato III-IV series					
Citroën	Jumper II-III series	≥ 2006	2524mm	5413mm	5998mm	6363mm
Peugeot	Boxer II-III series					

**WHAT YOU CAN ADD TO YOUR FIAMMA F80S**

- Enclosures - See page 82
- Panels - See page 72
- LED - See page 172
- Accessories - See page 40



FIAMMASTORE

CARRY-BIKE



COMFORT





# F80L

SUITABLE FOR MOTORHOMES AND CARAVANS



Roof winch awning F80L, particularly suitable for large vehicles, has the aesthetics of the F80s creating a family feeling with the Fiamma roof awnings.



**FEATURES:**

- Winch awnings for roof installation with practical visible loop
- Several types of dedicated brackets are available as options (p. 47)
- Length from 450 to 600
- Extension 275cm

**01 Visible loop**  
For maximum ease of use

**02 Brackets**  
Find brackets and adapters for every type of vehicle (p. 47)

**03 Strong structure**  
To guarantee solidity with 275cm extension

**04 Side Caps and Cover**  
Plastic side caps, painted aluminium cover

**05 Dual Shock-Absorber**  
Absorbs shocks in case of heavy stress

**06 Roller support**  
Facilitates the rolling up of the fabric

**07 Double LED preparation**  
Front and case box, LED light visible even when the awning is closed (p. 172)

**08 Secure Lock**  
Adjusts the height of the lead bar

**09 Triple guide**  
To install a front panel or Privacy and other accessories

**10 Arms**  
Enlarged section for greater strength and extension to 275cm. With provision to accommodate the Telescopic Rafter Arm Kit (p. 40)

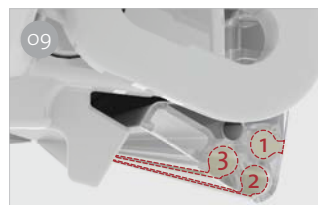

**MODELS AND DIMENSIONS**

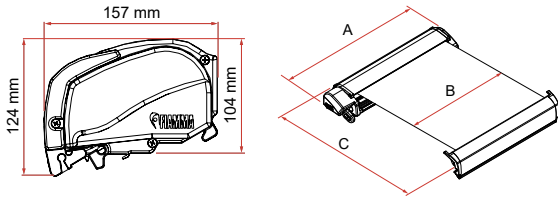

F80L	Length A	Length B	Extension C	Shade Surface	Weight	Item No. Polar White	Item No. Titanium	Item No. Deep Black
450 *	454cm	438cm	275cm	12m <sup>2</sup>	43,8kg	07840G03(X)	07842G03(X)	07841G03R
500 *	497cm	480cm		13,2m <sup>2</sup>	46,5kg	07840H03(X)	07842H03(X)	07841H03R
550 **	547cm	530cm		14,6m <sup>2</sup>	50,0kg	07840L03(X)	07842L03(X)	07841L03R
600 **	597cm	580cm		16m <sup>2</sup>	54,5kg	07840M03(X)	07842M03(X)	07841M03R

\* 1 Tension Rafter made of anodized aluminium included

\*\* 2 Tension Rafters made of anodized aluminium included

Specify the fabric colour you want when ordering by replacing (X) with: R=Royal Grey, Q=Royal Blue

**+ OPTIONAL - KIT TELESCOPIC RAFTER ARM**

Optional accessory that can be installed on the F80L awnings to guarantee maximum stability. It prevents the arms from closing, whatever the weather conditions\*, guaranteeing resistance even under heavy stress.



\* however, conscientious use is recommended, avoiding exposure to the risk of weather events for which a weather alert has been issued by the appropriate authorities.

**+ WHAT YOU CAN ADD TO YOUR FIAMMA F80L**

- Enclosures  
- See page 82
- Panels  
- See page 72
- LED  
- See page 172
- Accessories  
- See page 40







# F65eagle

SUITABLE FOR MOTORHOMES AND VAN CONVERSIONS



Automatic motorised awning, without support legs, with self-supporting arms. Motorised with new compact motor characterised by smaller size, simple construction, reliability and excellent performance. Roof-mounted and operated using the wall-mounted Control System.

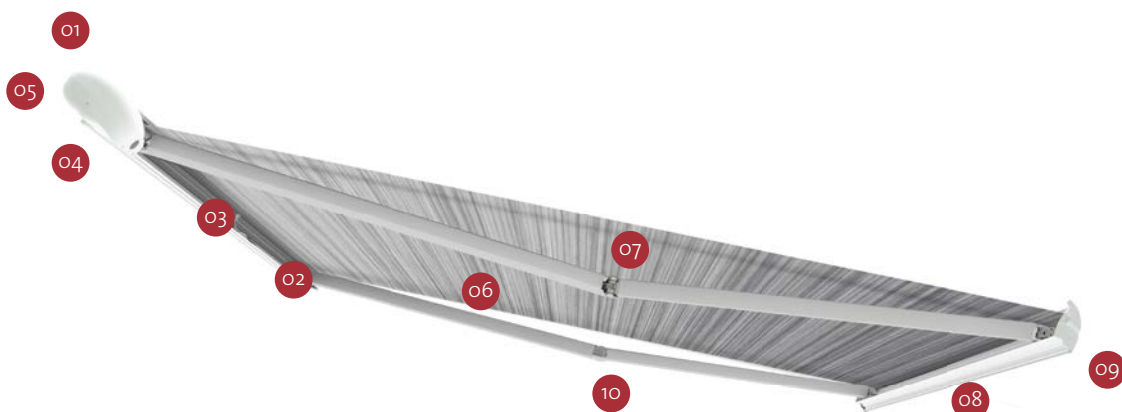

**FEATURES:**

- Motorised
- Self-supporting arms
- Brackets included for Ducato version, optional for 400 standard version (Adapter p. 58 and 63)
- Length: from 319 to 400

**01 Brackets**  
To find brackets and adapters for the standard version (400cm) (p. 60 and 65)

**02 Presto Fix**  
Guarantees perfect closure of the lead bar over time

**03 Roller support**  
Facilitates the rolling up of the fabric

**04 Double Block support**  
Allows the regulation of the inclination from 5° to 17° and reinforces the self-supporting arms, thus avoiding the use of support legs

**05 12V motor included**  
To operate the awning in one easy step

**06 Reinforced arms**  
Keep the fabric tensioned

**07 One Way Roll**  
Guide the rolling direction of the fabric

**08 Double guide**  
To install a front panel and other accessories

**09 Wind Detection System**  
Sensor that is automatically activated and closes the awning in case of strong wind

**10 LED preparation**  
Front. The cable ducts on the arms allow the passage of cables for the optional Fiamma LED kits (page 172)

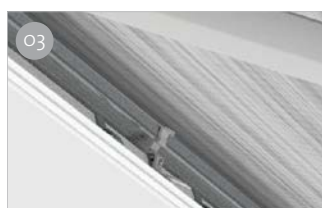

MODELS AND DIMENSIONS

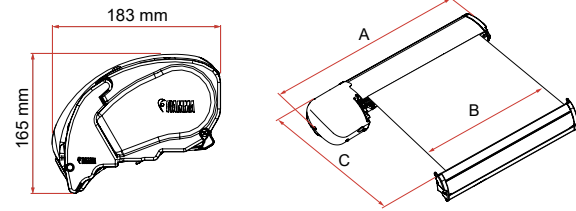

CASE BOX

- Polar White
- Titanium

FABRIC

- Royal Grey

F65eagle	Length A	Length B	Extension C	Shade Surface	Weight	Item No. Polar White	Item No. Titanium
319 *	320cm	285cm	250cm	7,2m <sup>2</sup>	30,0kg	08540F01R	-
369 *	370cm	335cm		8,3m <sup>2</sup>	34,0kg	08540G01R	-
399 *	405cm	369cm		9,2m <sup>2</sup>	37,0kg	08540H01R	-
400	420cm	380cm		9,5m <sup>2</sup>	37,5kg	08540C01R	08542C01R

\* The awning is delivered as standard with installation bracket.  
 Important: verify with your trusted dealer if your motorhome or motorcaravan is suitable for the installation of the F65eagle. The vehicle must be robust enough to support the weight and the tension of the open awning. Fiamma refuses all responsibility for damages to the roofs or for water ingress due to incorrect installation or due to installations on weak roofs.

WHAT YOU CAN ADD TO YOUR FIAMMA F65EAGLE

- LED - See page 172
- Accessories - See page 40







# F40van

SUITABLE FOR CAMPERVANS



Compact design, high performance. The sleek ultra for your campervans! Thanks to its small footprint and integrated brackets, it integrates perfectly into the vehicle and is quick and easy to remove.



**FEATURES:**

- Winch awning for roof installation with practical visible loop
- Several types of dedicated brackets are available as options (p. 46)
- Maximum leg height of 220cm makes maximum use of the awning height
- Not suitable for vehicles with lift roof
- Length 210 and 270

**01 Visible loop**  
For maximum ease of use

**02 Brackets**  
Find brackets and adapters for every type of vehicle (p. 46)

**03 Arms**  
Reinforced and with reduced section

**04 One Way Roll**  
Guide the rolling direction of the fabric

**06 Legs**  
With predefined position for fast and precise opening

**05 Double guide**  
To install a front panel or Room Van and other accessories

**+ AWNING INCLINATION**

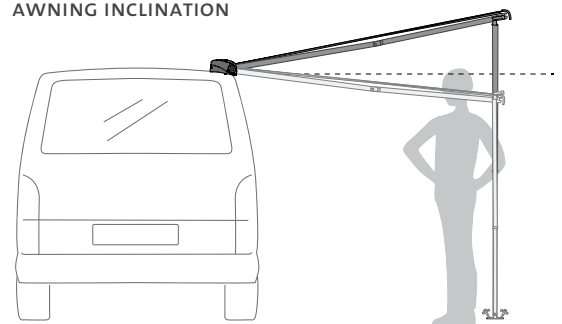

**MODELS AND DIMENSIONS**

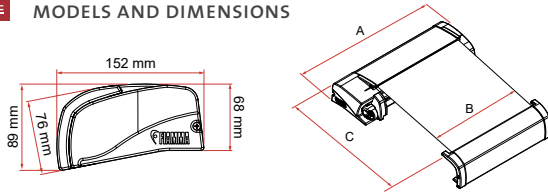

F40van	Length A	Length B	Extension C	Shade Surface	Weight	Item No.
210	210cm	199cm	150cm	2,9m <sup>2</sup>	17,0kg	07503Q01R
270	270cm	257cm	225cm	5,8m <sup>2</sup>	19,0kg	07503H01R

**CASE BOX**

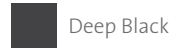

**FABRIC**



**+ OPTIONAL - RAFTER LED VAN**

Rafter for F40van awning, for an optimally stretched fabric.

It guarantees greater wind resistance and prevents the formation of water pockets in the event of rain, thanks to its installation perpendicular to the arms of the awning. It comes with LEDs to illuminate your holiday space.

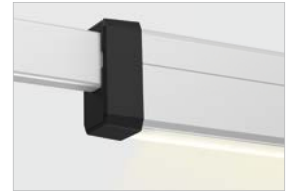

**+ WHAT YOU CAN ADD TO YOUR FIAMMA F40VAN**

- Enclosures - See page 82
- Panels - See page 72
- LED - See page 172
- Accessories - See page 40







# CaravanStore / XL

SUITABLE FOR CARAVANS



Manual awning for caravans very easy to install: only 45 seconds to open it completely! Legs and rafters are quick and easy to remove as they are integrated into the patented roller, which rolls and unrolls easily, without creasing.



**FEATURES:**

- Manual opening with telescopic legs integrated in the roller
- Installation on rail
- Integrated legs in the roller, facilitate gripping and make it easier to wind the fabric
- From size 360, the awning can be partially opened by attaching the legs to the wall
- Enlarged Zip, with larger Zip head for better grip
- Length from 190 to 550

**01 Installation**  
On rail: fast, quick and easy

**02 Bag**  
Comfortable and soft anti-scratch tape

**03 Easy regulation**  
Arm adjustment system with different fabric extension positions

**04 Integrated legs**  
Stored in the roller, telescopic and easy to take out

**05 Vehicle wall protection**  
All parts in contact with the vehicle are fitted with a rubber protection kit

**06 Double guide**  
To install a front panel or Privacy and other accessories

**07 Roller**  
Rolling up of the fabric in both directions

**08 LED optional**  
To light up your evenings (p. 172)

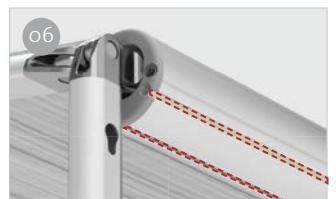

**+ WHAT YOU CAN ADD TO YOUR FIAMMA CARAVANSTORE**

Enclosures  
- See page 82

Panels  
- See page 72

LED  
- See page 172

Accessories  
- See page 40

MODELS AND DIMENSIONS

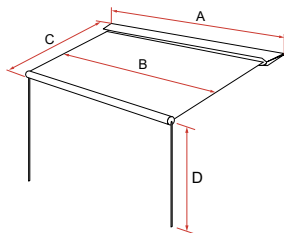
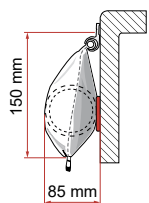

BAG



Grey

FABRIC



Royal Grey



Royal Blue

CaravanStore / XL	Length A	Length B	Extension C	Height from ground D	Shade Surface	Weight	Item No.
190	193cm	162cm	180cm	195cm	2,9m <sup>2</sup>	6,0kg	06760-01(X)
225	235cm	202cm	225cm	225cm	4,5m <sup>2</sup>	7,5kg	06760A01(X)
255	264cm	232cm			5,2m <sup>2</sup>	8,5kg	06760B01(X)
280	286cm	254cm			6,4m <sup>2</sup>	10,1kg	07740C01(X)
310	316cm	284cm			7,1m <sup>2</sup>	11,2kg	07740D01(X)
360	366cm	334cm	250cm	225cm	8,4m <sup>2</sup>	12,3kg	07740E01(X)
410 *	415cm	384cm			9,6m <sup>2</sup>	13,5kg	07740F01(X)
440 **	448cm	414cm			10,4m <sup>2</sup>	14,6kg	07740G01(X)
500 ***	497cm	465cm			11,6m <sup>2</sup>	15,8kg	07740H01(X)
550 ***	547cm	515cm			12,9m <sup>2</sup>	16,9kg	07740L01(X)

\* 1 tension Rafter CaravanStore included. \*\* 1 tension Rafter CaravanStore and 1 CaravanStore Support Leg included

\*\*\* 2 CaravanStore Support Leg included. Specify the fabric colour you want when ordering by replacing (X) with: R=Royal Grey, Q=Royal Blue







# F35pro

SUITABLE FOR CARAVANS, CAMPERVANS AND SUV



Lightweight but very strong, this aluminium awning with legs and rafters integrated into the roller is ideal if you want to go on an adventure in your minivan, 4x4, SUV or caravan.



**FEATURES:**

- Manual opening
- Easy installation on the wall, on roof bars or rail
- Wide range of brackets to fit your vehicle (p. 47)
- Possibility of raising the front to make maximum use of the awning height
- Length from 180 to 300

**O1 Brackets**

Wide range of brackets purchased separately (p. 47)

**O2 Compact case box**

The awning is contained in a stylish anodised aluminium case box

**O3 Double guide**

To install a front panel or Privacy and other accessories

**O4 Integrated legs**

Stored in the roller, telescopic and easy to take out

**O5 Reinforced arms**

Easy to adjust, keep the fabric tensioned

**O6 Roller**

Rolling up of the fabric in both directions

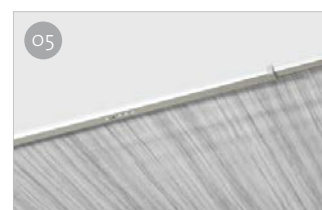
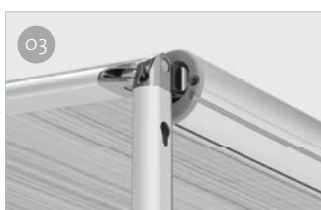

☰ MODELS AND DIMENSIONS

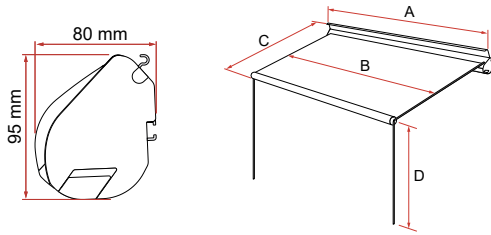

☰ CASE BOX

- Titanium
- Deep Black

☰ FABRIC

- Royal Grey
- Royal Blue

F35pro	Length A	Length B	Extension C	Height from ground D	Shade Surface	Weight	Item No. Titanium	Item No. Deep Black
180	183cm	162cm	180cm	195cm	2,9m <sup>2</sup>	8,5kg	06762-01(X)	06458-01R
220	223cm	202cm	225cm	225cm	4,5m <sup>2</sup>	10,5kg	06762A01(X)	06458A01R
250	253cm	232cm			5,2m <sup>2</sup>	11,5kg	06762B01(X)	06458B01R
270	273cm	254cm			5,7m <sup>2</sup>	13,0kg	06762C01(X)	06458C01R
300	303cm	282cm			6,4m <sup>2</sup>	14,0kg	06762D01(X)	06458D01R

Specify the fabric colour you want when ordering by replacing (X) with: R=Royal Grey, Q=Royal Blue

☰ WHAT YOU CAN ADD TO YOUR FIAMMA F35PRO

- Enclosures  
- See page 82
- Panels  
- See page 72
- LED  
- See page 172
- Accessories  
- See page 40







# Compass

SUITABLE FOR CAMPERVANS AND SUV



The perfect awning that provides a large area of shade on two sides of the vehicle, thanks to the circular compass opening. Ideal for every occasion and for short stops, it is very easy to use.

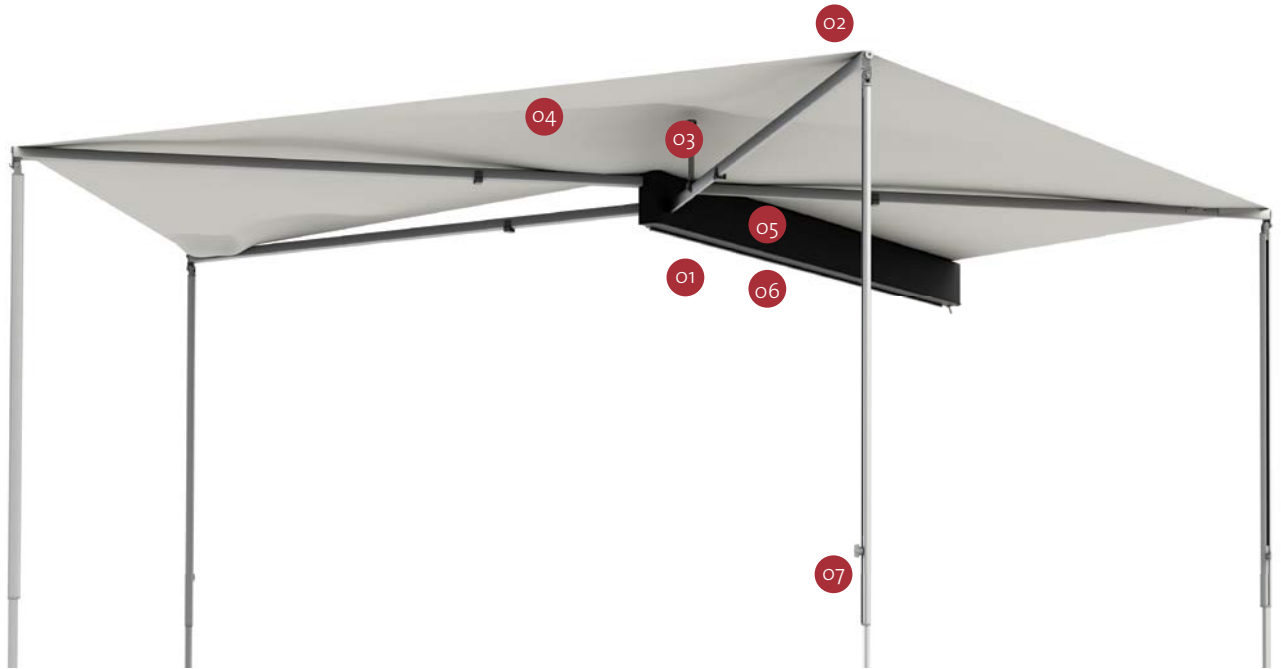

**FEATURES:**

- Manual opening
- 270° compass opening
- Several types of dedicated brackets are available as options (p. 47)

**01 Brackets**

Can be purchased separately (p. 46)

**02 Compass opening**

270° opening around the vehicle

**03 Vertical support**

For a canopy that is always perfectly tensioned

**04 Fabric**

Attached to the bag with a sturdy zipper, easily removable

**05 Bag**

Super strong, waterproof and UV-resistant

**06 Resistant to torsion**

Guaranteed thanks to the robust aluminium structure

**07 Secure Lock**

Adjusts the height of the lead bar



MODELS AND DIMENSIONS

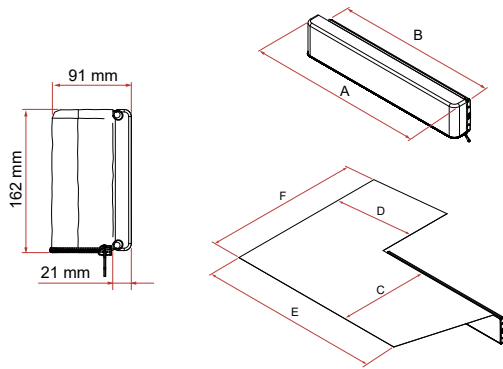

BAG

- Silver
- Black

FABRIC

- Light Grey

Compass	Bag length (A)	Support length (B)	Min height from ground	Extension (C)	Extension (D)	Length (E)	Length (F)
220	220cm	214cm	200cm	148cm	145cm	300cm	336cm
260	260cm	254cm		176cm	173cm	358cm	370cm

Compass	Shade surface	Weight	Item No. Silver	Item No. Black	Only suitable for left hand drive vehicles
220	7,2m <sup>2</sup>	16,5kg	07260A01J	07261A01J	
260	9,9m <sup>2</sup>	19,5kg	07260B01J	07261B01J	

WHAT YOU CAN ADD TO YOUR FIAMMA COMPASS

Accessories  
- See page 40









### MOTOR KIT COMPACT F65L

Compact motor for F65L awning, characterised by smaller size, simple construction, reliability and excellent performance. Equipped with wall-mounted button Control System.



### MOTOR KIT COMPACT F45

Compact motor for F45s and F45L awnings, characterised by smaller size, simple construction, reliability and excellent performance. Equipped with wall-mounted button Control System.



### MOTOR KIT ADVANCED F45

To manage your F45s/L awning thanks to the practical Fiamma App (for Android and iOS): opening and closing, LED control (on/off/dimming). The motor is also equipped with wall-mounted button Control System.



#### CHOOSE THE MODEL THAT SUITS YOU

	Power supply	Weight	Item No. Polar White	Item No. Titanium	Item No. Deep Black
Motor Kit Compact F45s	12 V	2,0kg	08319-01P	08319-01T	08319-01H
Motor Kit Advanced F45s		2,1kg	08455-01P	08455-01T	08455-01H
Motor Kit Compact F45L		2,5kg	08318-01P	08318-01T	08318-01H
Motor Kit Advanced F45L		2,6kg	08451-01P	08451-01T	08451-01H
Motor Kit Compact F65L		2,0kg	08448-01P	08448-01T	08448-01H

F45s for RHD vehicles (UK) available on request.



# Accessories

How to make your awning even more effective and performing?  
Simple: just add one or more dedicated Fiamma accessories. Discover them all!



## KIT TELESCOPIC RAFTER ARM

Telescopic arm support: optional accessory that can be installed on the F80s\* (from length 320) and F80L\* awnings to guarantee maximum stability. It prevents the arms from closing, whatever the weather conditions\*\*, guaranteeing resistance even under heavy stress. The F80s/L awnings will have their arms prepared to accommodate this new accessory.

### FEATURES:

- Integrated in the awning arms, can be used as required
- Quick and easy to use, disengages with a simple click



**01**  
**Closed**  
Integrated into the awning arms



**02**  
**Telescopic**  
Extends and attaches to the front



**03**  
**Coupling**  
To the front of the awning



**04**  
**Open**  
Provides maximum stability

\* ensure that the awning is fitted with arms designed to receive the accessory  
\*\* however, conscientious use is recommended, avoiding exposure to the risk of weather events for which a weather alert has been issued by the appropriate authorities.

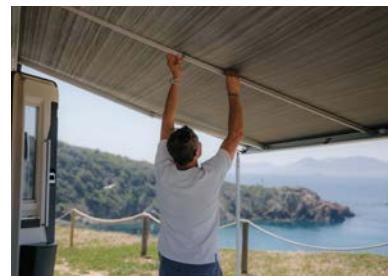

## RAFTER

Canvas always perfectly taut and noise-proof? It can be done, thanks to this practical telescopic rafter adjustable in length, from 145cm to 275cm.

### WHICH AWNINGS DOES IT FIT?

F45s/L - F80s/L - F65s/L with extension up to 275cm and 600cm length.



## RAFTER PRO

Curved rafter, raises the canvas slightly for optimal tensioning. Adjustable in length from 145cm to 250cm. Not recommended for use at high temperatures.

### WHICH AWNINGS DOES IT FIT?

F45s/L - F80s - F65s/L with extension up to 250cm and length 550cm.

### CHOOSE THE MODEL THAT SUITS YOU

	Weight	Item No.		Weight	Item No.
Kit Telescopic Rafter Arm F80s (2 pcs)	0,2kg each	08832-01-	Rafter	0,8kg	98655A007
Kit Telescopic Rafter Arm F80L (2 pcs)	0,26kg each	08834-01-	Rafter Pro	0,8kg	98655A002



**RAFTER LED**

Restyling featuring easier and more practical awning attachment, COB LEDs\* and power supply via jack connector and cigarette lighter (12V socket).

**WHICH AWNINGS DOES IT FIT?**

F45s/L - F80s

\* Chip On Board. COB LED strips are LED strips that create homogeneous lines of light without the classic dotted effect



**RAFTER LED CARAVANSTORE**

Specifically, for CaravanStore awning. Distinct restyling with more convenient and effective awning attachment, COB LEDs\* and power supply via jack connector and cigarette lighter (12V socket).

**WHICH AWNINGS DOES IT FIT?**

CaravanStore, CaravanStore ZIP.



**RAFTER LED VAN**

It guarantees an optimally stretched fabric, greater wind resistance and prevents the formation of water pockets in the event of rain, thanks to the perpendicular installation with respect to the arms of the awning. It comes with COB LEDs\* to illuminate your holiday space.

**WHICH AWNINGS DOES IT FIT?**

F43van 270, F40van and F45s 260.

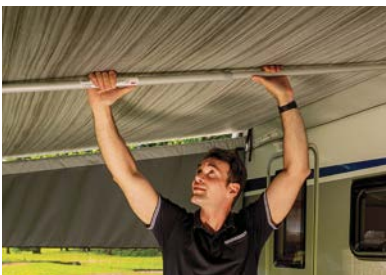

**RAFTER CARAVANSTORE / XL**

This practical 30mm diameter anodised aluminium tension rafter keeps the awning fabric taut and makes it silent and windproof. It is adjustable in length from a minimum of 150cm to a maximum of 250cm.

**WHICH AWNINGS DOES IT FIT?**

F35pro and CaravanStore awnings with an extension of 225cm and 250cm (CaravanStore XL version).



**MAGICRAFTER**

And as if by magic, this rafter will give your awning greater stability: just attach it to the arm joints.

**WHICH AWNINGS DOES IT FIT?**

Awnings from 250cm to 400cm in length.



**MAGICRAFTER PRO**

This pole is designed to give greater stability to your awning. It is easily attached to the arm joints: the two vertical supports provide optimal tension of the canvas. Caution: not recommended for use at high temperatures.

**WHICH AWNINGS DOES IT FIT?**

Awnings from 350cm to 450cm long.

**☰ CHOOSE THE MODEL THAT SUITS YOU**

	Weight	Item No.		Weight	Item No.
Rafter LED	1,6kg	98655A850	Rafter CaravanStore XL	0,6kg	03888-02-
Rafter LED CaravanStore	1,4kg	98655A902	Magicrafter	0,8kg	98655-716
Rafter LED Van	1,3kg	98655A134	Magicrafter Pro	0,8kg	98655-847



# Accessories

How to make your awning even more effective and performing?  
Simple: just add one or more dedicated Fiamma accessories. Discover them all!



## TIE DOWN

This kit with anchoring straps optimally fixes wall or roof awnings to the ground. It consists of an 11m adjustable strap, two pegs and a tensioning spring.



## TIE DOWN S

Anchoring kit for easy and solid attachment to the ground from the front of awnings, also designed to be attached to the side of Privacy Room. It consists of 2 adjustable 300cm bands, 2 pegs, 2 tension springs and 2 front hooks. It is also designed to be attached to the Privacy side panel. CaravanStore Tie Down S version suitable for CS and F35pro (with leg attachment).



## KIT REPAIR PLUS

Has the awning cover been damaged? Repair it quickly with this kit consisting of 3 transparent PVC adhesive strips!

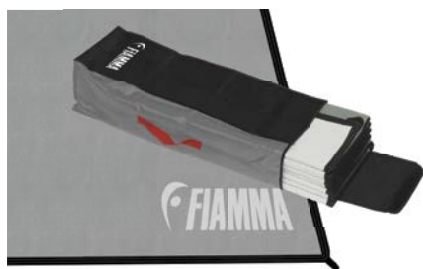

## PATIO MAT / PATIO MAT LIGHT

Comfortable completion mat for your Privacy. It is made of breathable, self-extinguishing and UV-resistant polypropylene. Also available in a Light version featuring a lighter fabric, without edging and equipped with a standard bag. Patio Bag is optionally available for the Patio Mat.



## SAFETY STRIP

Close the front of your awning more securely with this 39cm strap for F35pro. Perfect for driving over rough terrain.



## SPOILER S

The unique design allows for less wind resistance of your awning. Can also be used with other brands of awning. It is made of thermoformed ABS-PLUS with UV protection.





**KIT AWNING PEGS**

These robust screw-in pegs are ideal for tents, Privacy Rooms and mats. They can be screwed into the ground by hand - ideal for soft, sandy ground.



**KIT AWNING PLATE**

Don't let your awning get away! Ideal for fixing the front poles to the ground, they increase resistance in case of wind. They fit all types of Fiamma and Thule/Omnistor awning legs.



**KIT AWNING HANGERS**

This practical kit has 6 hooks that fit into the front of the awning and allow you to hang small light objects, so that they are always tidy and close at hand.

**WHICH AWNINGS DOES IT FIT?**  
Awnings with 7mm slots.



**CRANK HANDLE**

Say goodbye to fatigue with this crank handle, available in 3 different lengths: Short, Standard and Telescopic.



**CHOOSE THE MODEL THAT SUITS YOU**

	Weight	Item No.
Tie Down Yellow / Black	1,2kg	98655-128 / 98655-129
Tie Down S Yellow / Black	1,2kg	98655-567 / 98655-133
Tie Down S CaravanStore Black	1,2kg	98655-638
Kit Repair Plus	0,1kg	98655-466
Patio-Mat 260	2,5kg	08756-01-
Patio-Mat 290	3,2kg	07681-01-
Patio-Mat 340	3,5kg	07682-01-
Patio-Mat 390	3,8kg	07683-01-
Patio-Mat 440	4,2kg	07684-01-
Patio-Mat 490	4,6kg	07701-01-
Patio-Mat 540	5,1kg	08757-01-
Patio-Bag	0,2kg	08206-01-
Patio Mat Light 290	2,2kg	08839-01-
Patio Mat Light 340	2,6kg	08840-01-
Patio Mat Light 390	2,9kg	08841-01-
Patio Mat Light 440	3,3kg	08842-01-
Safety Strip	0,1kg	98655Z006
Spoiler S	0,1kg	05150-01A
Kit Awning Pegs	0,6kg	98655-880
Kit Awning Plate	0,3kg	98655-724
Kit Awning Hangers	0,8kg	98655-743
Crank Handle Short	0,3kg	01756B01A
Crank Handle Standard	0,4kg	04660-01-
Crank Handle Telescopic	0,7kg	03878C01-



# Rain Guard and Cover

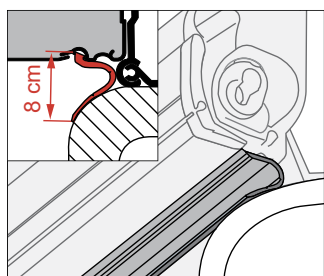

## RAIN GUARD LOWER

Hermetic seal for F45s/L awnings with suspended installation spaced from the wall. It can be installed on the slot of the case box.

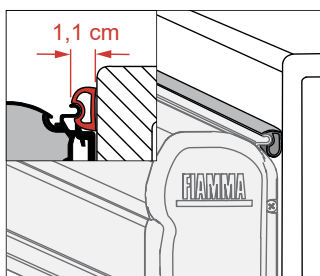

## RAIN GUARD S

Hermetic seal for awnings mounted with the AS 120 bracket on flat walls.

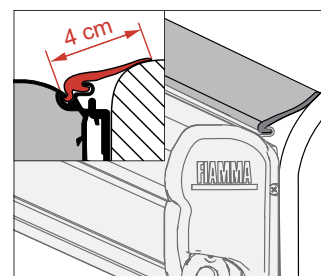

## RAIN GUARD M

Hermetic seal for awnings spaced up to 4cm from the wall or on curved walls.

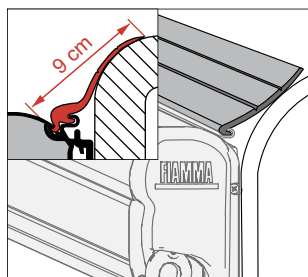

## RAIN GUARD L

Hermetic seal for awnings spaced up to 9cm from the wall or on curved walls.

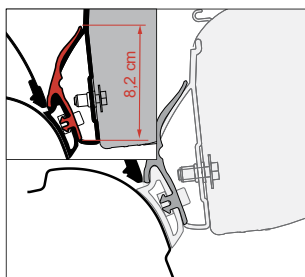

## KIT RAIN GUARD CALIFORNIA

Hermetic seal for F45s and F35pro awnings installed on VW California. Length 200cm.

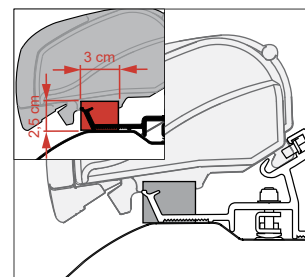

## KIT RAIN GUARD F80

Hermetic seal for roof awnings F80s, F65s and F65L, they cover the entire space between the roof and the awning. Available in two versions: 450cm and 50cm kits. Made of EPDM material.

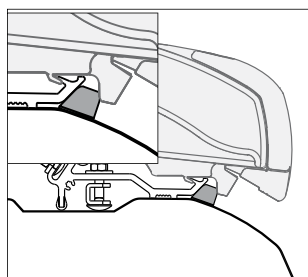

## KIT RAIN GUARD SLIM F80s DUCATO

Black rubber seal, specifically for F80s Ducato with low-profile brackets, can be shortened depending on the size of the awning.

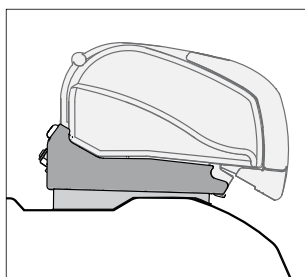

## KIT COVER F80s DUCATO

Black plastic covers, specifically for F80s Ducato with low-profile brackets, to improve integration of the bracket with the vehicle.

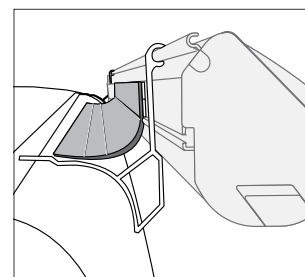

## KIT RAIN GUARD VAN

Kit for F45s, F43van and F35pro awnings with suspended installation on camper vans, spaced from the wall. Length 300cm.

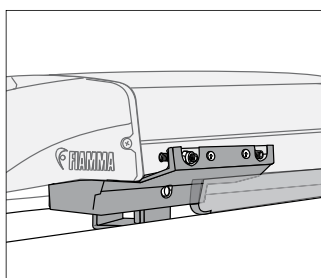

**KIT RAIN GUARD + COVER F40 VAN - VW T5 / T6**

Kit for VW T5 / T6 vehicles consisting of hermetic seal and cover to optimally integrate the bracket with the F40van awning and the vehicle.

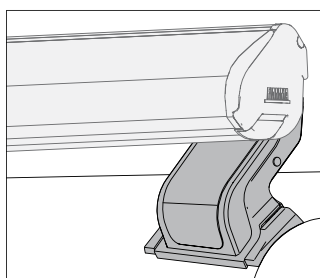

**KIT COVER VW CADDY MAXI**

Black plastic covers in combination with bracket Kit VW Caddy Maxi Lift Roof for F35pro to improve the integration of the bracket with the vehicle.

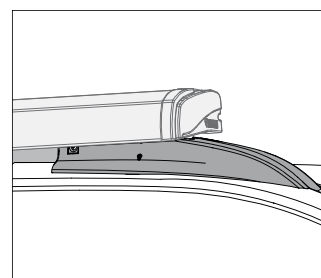

**KIT RAIN GUARD + COVER F40 VAN - MERCEDES V CLASS**

Kit for Mercedes V Class vehicles consisting of hermetic seal and cover to optimally integrate the bracket with the F40van awning and the vehicle.

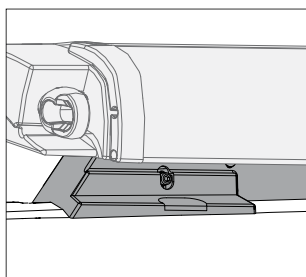

**KIT RAIN GUARD + COVER F40 VAN - FORD CUSTOM**

Kit for Ford Custom vehicles consisting of hermetic seal and cover to optimally integrate the bracket with the F40van awning and the vehicle.

**CHOOSE THE MODEL THAT SUITS YOU**

	Rail length	Weight	Item No.	In combination with bracket kit:
Rain Guard Lower	Sold by meter	0,35kg/m	06299-01-	-
Kit Rain Guard Lower 550	550cm	1,9kg	98655Z017	-
Rain Guard S	Sold by meter	0,25kg/m	03910-01-	-
Kit Rain Guard S 550	550cm	0,8kg	98655Z014	-
Rain Guard M	Sold by meter	0,25kg/m	03477-01-	-
Kit Rain Guard M 550	550cm	1,4kg	98655Z015	-
Rain Guard L	Sold by meter	0,30kg/m	04629-01-	-
Kit Rain Guard L 550	550cm	3,1kg	98655Z016	-
Kit Rain Guard California	200cm	0,70kg	98655-663	-
Kit Rain Guard Van	300cm	0,80kg	98655-947	-
Kit Rain Guard F80/F65	450cm	1,10kg	98655-020	-
Kit Rain Guard F80/F65 50	50cm	0,10kg	98655Z019	-
Kit Rain Guard Slim F80s Ducato ***	450cm	0,31kg	98655Z137	98655Z093 98655Z103 98655Z104
Kit Cover F80s Ducato ***	-	0,50kg	98655Z118	98655Z093 98655Z103 98655Z104
Kit Rain Guard F40van VWT5/T6 *	270cm	0,80kg	98655Z039	98655Z152 98655Z153 ** 98655Z041 **
Kit Rain Guard F40van Ford Custom L1 *	2x 100cm	0,80kg	98655Z052	98655Z044
Kit Rain Guard F40van Ford Custom L1 * **	2x 100cm	0,80kg	98655Z047	98655Z046
Kit Rain Guard F40van Ford Custom L2 *	2x 110cm	0,80kg	98655Z054	98655Z045
Kit Rain Guard F40van Ford Custom L2 * **	2x 110cm	0,80kg	98655Z053	98655Z045
Kit Rain Guard F40van Mercedes V Class *	2x 110cm	0,80kg	98655Z077	98655Z078
Kit Cover VW Caddy Maxi	-	0,30kg	98655Z094	98655Z109

\* The Kit Rain Guard F40van are complete with a cover to integrate the bracket and awning with the vehicle.  
 \*\* For right-hand drive (RHD) vehicles  
 \*\*\* Standard for brackets 98655Z148, 98655Z149, 98655Z150



# F45

Adapter AS	48
Adapter D	48
Adapter T / U / B / C	49
Arca	48
Bailey MK 1	52
Bailey MK 2	52
Bürstner	48
Challenger Chausson	48
Combi Rail Bracket (Rail Brandrup - Vamoose)	54
Dethleffs Globebus	50
Eriba Touring	52
Eura Mobil Karmann	50
Fiat Ducato - Renault Master	53
Fiat Ducato H2 - Citroën Jumper H2 - Peugeot Boxer H2 ( ≥ 1994 ≤ 2006)	53
Fiat Ducato H2 - Citroën Jumper H2 - Peugeot Boxer H2 ( ≥ 2006)	53
Fiat Ducato H2 Lift Roof - Hymercar / Pössl Lift Roof	53
Fiat Ducato H2 Roof Rail - Alu-Line Style	53
Fiat Ducato with Roof Rack	53
Fiberglass Roof	52
Fleurette	48
Ford Custom Lift Roof	56
Ford Custom Nugget High Roof	57
Ford Custom Nugget Lift Roof	57
Ford Transit H2 / H3 ≤ 2014	52
Ford Transit H3 ≥ 2014	52
High Roof Adapter Westfalia	57
Hymer / Van B2	49
Hymer ≥ 2016	51
Hymer S	50
Hymer S-E Klasse	50
Hymercamp	51
Kit AS	48
Kit Auto	57
Kit Caravan	52
Kit Multi	52
Kit Roof Adapter	48
Kit Roof Rail	57
Kit S	48
Kit Van	53
Kit Wall Adapter	49
Laika Ecovip - Bürstner - Hobby / Adapter Laika Ecovip	49
Laika Ecovip 07	49
Laika Rexosline - Ecovip 07 - Kreos 09	50
Laika X	49
Mercedes Sprinter H3 - Sprinter H3 Westfalia - VW Crafter H3	52
Mercedes Vito	57
Pilote Explorateur	50
Rail	48
Rapido Serie S6 > 2024	51
Rapido Serie 6	51
Rapido Serie 7-8	51

Rapido Serie 9	51
Rapido Serie 9dF - 9M - 10	51
Renault Master H2 - Opel Movano H2 - Nissan Interstar H2	53
Renault Trafic - Opel Vivaro - Nissan NV 300 - Fiat Talento	56
Renault Trafic - Opel Vivaro - Nissan Primastar	56
V Class Marco Polo	56
Voyageur	50
VW T3	56
VW T4 Brandrup	55
VW T4 - VW T4 Lift Roof	55
VW T5 / T6 Lift Roof	55
VW T5 / T6 Multivan Transporter	55
VW T5 / T6 Multirail Reimo	55
Wingamm Oasi	50

# F43van

Combi Rail Bracket (Rail Brandrup - Vamoose)	54
Ford Custom / Lift Roof	56
Ford Custom Nugget Lift Roof	57
Kit Auto	57
Kit Roof Rail	57
Mercedes Vito	57
PSA	56
Renault Trafic - Opel Vivaro - Nissan Primastar	56
Renault Trafic - Opel Vivaro - Nissan NV300 - Fiat Talento	56
V Class Marco Polo	56
VW T3	56
VW T4 - Brandrup	55
VW T5 / T6 California	55
VW T5 / T6 Multivan Transporter	55
VW T5 / T6 Lift Roof	55
VW T5 / T6 Multirail Reimo / Multivan with Rail	55

# F40van

Adapter PSA	64
Ford Custom L1 / Ford Custom L2	65
Mercedes V Class	64
NV 350	65
NV 200	65
Renault Trafic L1 / Renault Trafic L2	64
VW T5 / T6 Rail	64
VW T5 / T6	64

All bracket codes in the following pages are suitable for the left guide unless otherwise indicated.  
(\*right guide - \*\*right and left guide)

## F80

Adapter Caravan Roof	60
Adria Caravan	60
Arca Mobilvetta K-Yacht	58
Autocruise	59
Bailey	60
Caravan Standard	61
Carthago Chic Rapido i80 - i90	58
Carthago Malibu	59
Fiat Ducato / Citroën Jumper / Peugeot Boxer - Low profile (L2/L3 - ≥ 2006)	62
Fiat Ducato / Citroën Jumper / Peugeot Boxer - H2 - L2/L3 (≥ 2006)	62
Fiat Ducato / Citroën Jumper / Peugeot Boxer - H2 - L4 (≥ 2006 - Low profile)	62
Fiat Ducato / Citroën Jumper / Peugeot Boxer - H2 - L4 (≥ 2006)	62
Fiat Ducato / Citroën Jumper / Peugeot Boxer - H2 (≥ 1994 ≤ 2006 - Low profile)	63
Fiat Ducato / Citroën Jumper / Peugeot Boxer - H2 (≥ 1994 ≤ 2006)	63
Fiat Ducato / Citroën Jumper / Peugeot Boxer - H3	62
Fiat Ducato H2 Skyroof	62
Ford Transit H3	61
Ford Transit Van H2	62
Giottiline - Fendt	58
Hobby Caravan	61
Hobby Easy / Ontour / Adria Adora	60
Hobby Excellent	60
Hobby Premium	61
Hobby Premium & Ontour	61
Hymmer	59
Iveco Daily H2	63
Kit Caravan Roof	60
Kit Caravan Standard	61
Kit Fixing Bar	60
Kit Standard	58
Laika Kreos 2005	58
Laika Kreos 21	58
Laika Ecovip / Rexosline / Kreos >09 <21	58
Laika Rexosline / Kreos 09	58
LMC - TEC	59
LMC Adapter Caravan Roof	60
Mercedes Sprinter - Roof Rail	63
Mercedes Sprinter / VW Crafter High Roof	63
Rapido C55i C86i	59
Rapido C Line	59
Rapido Distinction	59
Renault Master H2	63
Renault Master H2 - ≥ 2010	63
Smart Clamp Ducato	62
Sprinter F6Seagle	63
Standard F6Seagle 400	58
VW Crafter - Roof Rail	64
VW Crafter H3	64

## F35pro

Brandrup VW T4	66
Campêrêve Cap Road	65
Class V Marco Polo	67
Combi Rail Bracket (Rail Brandrup - Vamoose)	67
Eriba Touring	68
Ford Custom Lift Roof	68
Ford Custom Cap Coast / Capland / Caplife	68
Ford Custom Capland / Capfun	68
Ford Custom Groupe Rapido	68
Kit Auto	68
Kit Standard	68
Mercedes Viano / Marco Polo / Vito / V Class	67
Mercedes Vito / Vito Marco Polo	67
Mercedes Vito Jules Verne	67
Nissan NV200	67
PSA	65
Rail	68
Renault Trafic / Opel Vivaro / Fiat Talento / Nissan Primastar	67
Renault Trafic / Opel Vivaro / Fiat Talento / / Rapido Mirande S	67
VW Caddy Maxi	65
VW Caddy Maxi Lift Roof	65
VW T3 / T3 Lift Roof	66
VW T4 Lift Roof	66
VW T5 / T6 California	66
VW T5 / T6 Multirail Reimo	66
VW T5 / T6 Multivan Transporter	66
VW T5 / T6 Multivan Transporter (Roof Rail)	66
VW T6 Kepler	66

## Compass

Kit Auto	
Kit Roof Rail	
Renault Trafic	69
VW T5 / T6 Transporter / Multivan Compass	

## CaravanStore

Hobby CaravanStore	69
--------------------	----

All bracket codes in the following pages are suitable for the left guide unless otherwise indicated.  
(\*right guide - \*\*right and left guide)



# F45

## ADAPTER AS / KIT S / KIT AS

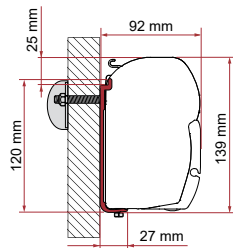

	Quantity / Length	Item No.
Adapter AS 300	1 x 300cm	98655-503
Adapter AS 350	1 x 350cm	98655-504
Adapter AS 400	1 x 400cm	98655-505
Adapter AS 450	1 x 450cm	98655-928
Kit S 120	1 x 12cm	98655-392
Kit S 400	1 x 40cm	98655-381
Kit AS 110 (Standard from 190 to 230cm)	2 x 12cm	98655Z007
Kit AS 120 (Standard from 260 to 400cm)	2 x 12cm - 1 x 8cm	98655-391
Kit AS 400 (Standard from 450 to 500cm)	2 x 40cm - 1 x 12cm	98655-390
Kit AS 400 L (Standard from 550cm)	4 x 40cm	98655-393

## ADAPTER D

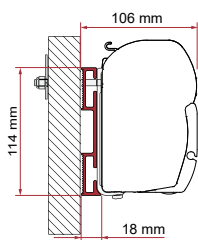

	Quantity / Length	Item No.
Adapter D	1 x 8cm	98655-021
	1 x 12cm	98655-022

## KIT BÜRSTNER

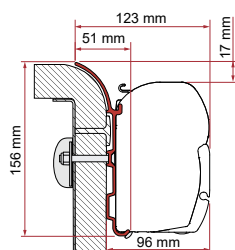

	Quantity / Length	Item No.
Kit Bürstner	2 x 12cm - 1 x 8cm	98655-749

## RAIL

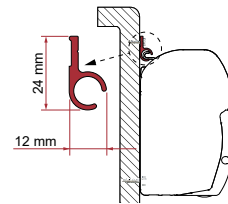

	Quantity / Length	Item No.
Rail	1 x 300cm	02361-01A
	1 x 400cm	02361-01C

## KIT CHALLENGER CHAUSSON



Eden Allegro

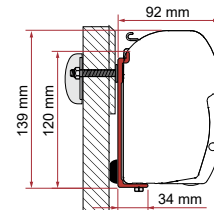

	Quantity / Length	Item No.
Kit Challenger Chausson	2 x 8cm - 1 x 40cm	98655-258

## KIT ROOF ADAPTER

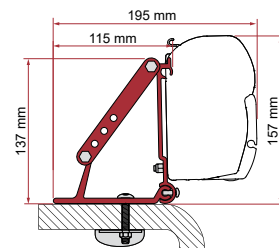

	Quantity / Length	Item No.
Kit Roof Adapter	3 x 8cm	98655-316

## KIT FLEURETTE

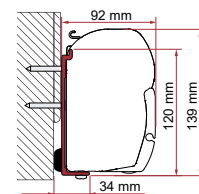

	Quantity / Length	Item No.
Kit Fleurette	1 x 8cm - 2 x 12cm	98655-082

## ADAPTER ARCA

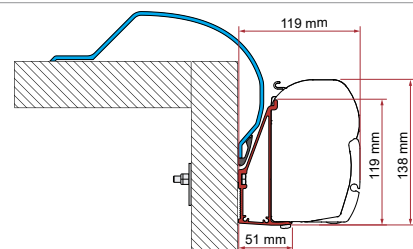

	Quantity / Length	Item No.
Adapter Arca	1 x 400cm	98655-852

● black finish brackets

\* for right hand drive

\*\* for left and right hand drive



**ADAPTER T / U / B / C**

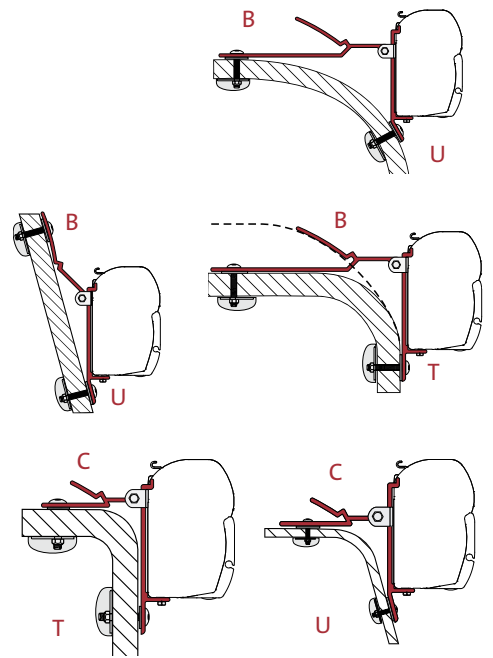
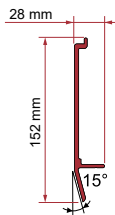
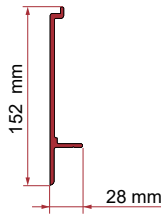

	Quantity	Item No.
Adapter T	1 pc	02437-01-

	Quantity	Item No.
Adapter U	1 pc	02437A01-

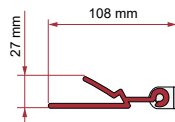
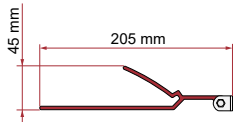

	Quantity	Item No.
Adapter B	1 pc	02096-01-

	Quantity	Item No.
Adapter C	1 pc	02097-01-

**KIT / ADAPTER HYMER / VAN B2**

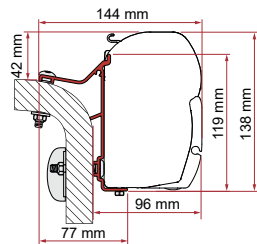

	Quantity / Length	Item No.
Kit Hymer / Van B2	2 x 8cm - 2 x 35cm	98655-243
	1 x 350cm	98655-244
Adapter Hymer / Van B2*	1 x 400cm	98655-245
	1 x 450cm	98655-246

\*Hymermobile B - Classic B - Klasse - Starline

**KIT WALL ADAPTER**

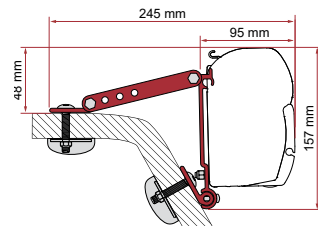

	Quantity / Length	Item No.
Kit Wall Adapter	3 x 8cm	98655-318

**KIT LAIKA X**

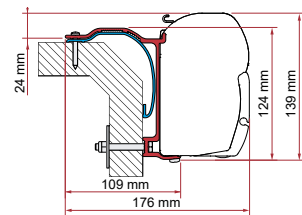

	Quantity / Length	Item No.
Kit Laika X	3 x 15cm	98655-761

**KIT LAIKA ECOVIP - BÜRSTNER - HOBBY / ADAPTER LAIKA ECOVIP**

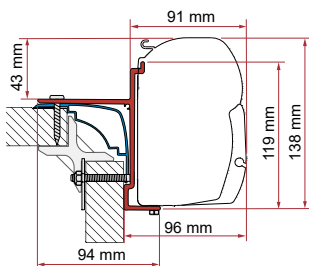

	Quantity / Length	Item No.
Kit Laika Ecovip - Bürstner - Hobby	3 x 15cm - 1 x 12cm	98655-357
Adapter Laika Ecovip	1 x 390cm	98655-469

**KIT LAIKA ECOVIP 07**



For awnings from 4m

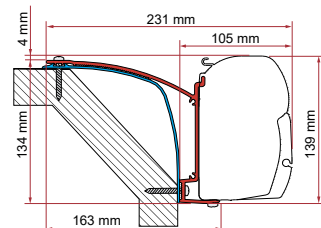

	Quantity / Length	Item No.
Kit Laika Ecovip 07	3 x 15cm	98655-467

- black finish brackets
- \* for right hand drive
- \*\* for left and right hand drive



**KIT LAIKA REXOSLINE - ECOVIP 07 - KREOS 09**

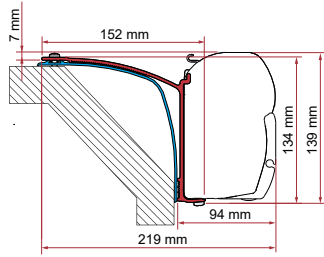

Quantity / Length      Item No.

Kit Laika Rexosline - Ecovip 07 - Kreos 09      3 x 15cm      98655-418

**ADAPTER EURA MOBIL KARMANN**

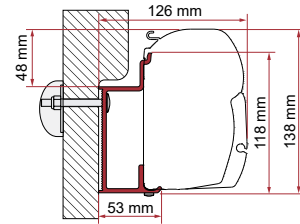

Quantity / Length      Item No.

Adapter Eura Mobil Karmann      1 x 350cm      98655-764  
 1 x 400cm      98655-765  
 1 x 450cm      98655-766

**KIT VOYAGEUR**

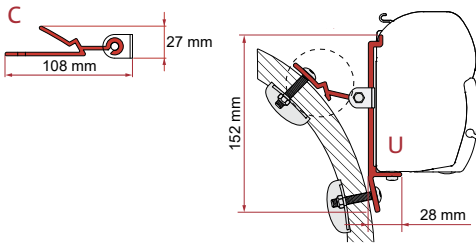

Quantity / Length      Item No.

Kit Voyageur      3 x 8cm - 3 x 8cm      02097-01- (1 pc) + 02437A01- (1pc)

**KIT PILOTE EXPLORATEUR**

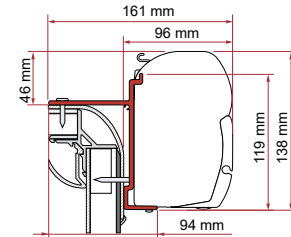

Quantity / Length      Item No.

Kit Pilote Explorateur      3 x 15cm      98655-729

**KIT DETHLEFFS GLOBEBUS**

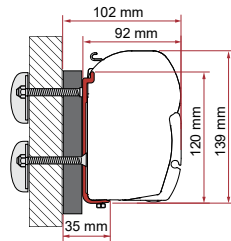

Quantity / Length      Item No.

Kit Dethleffs Globebus      3 x 12cm      98655-730

**ADAPTER HYMER S-E KLASSE**



Hymermobile S - Klasse 650, 740, 820 Esterel ≥ 2007

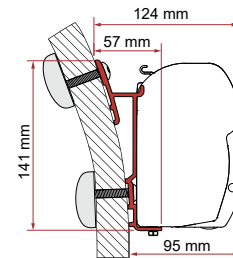

Quantity / Length      Item No.

Adapter Hymer S-E Klasse      1 x 400cm      98655-249  
 1 x 450cm      98655-250

**KIT HYMER S**

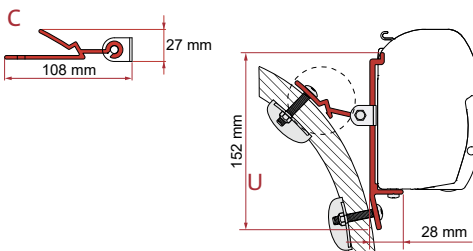

Quantity / Length      Item No.

Kit Hymer S      3 x 8cm - 3 x 8cm      02097-01- (1pc) + 02437A01- (1pc)

**ADAPTER WINGAMM OASI**



≥ 2006

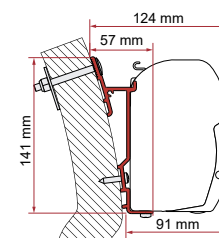

Quantity / Length      Item No.

Adapter Wingamm Oasi      1 x 230cm      98655-929  
 1 x 300cm      98655-930  
 1 x 350cm      98655-931

● black finish brackets

\* for right hand drive

\*\* for left and right hand drive

**KIT / ADAPTER HYMERCAMP**

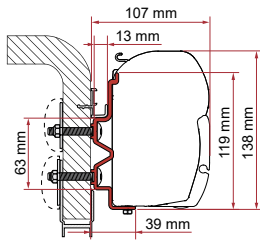

	Quantity / Length	Item No.
Kit Hymercamp	3 x 12cm	98655-278
	Quantity / Length	Item No.
	1 x 300cm	98655-277
	1 x 350cm	98655-276
Adapter Hymercamp*	1 x 400cm	98655-274
	1 x 450cm	98655-275
	1 x 500cm	98655-273

\* Hymercamp Swing - Starline - Hobby Van - Caravan Hobby 09

**KIT / ADAPTER HYMER ≥ 2016**

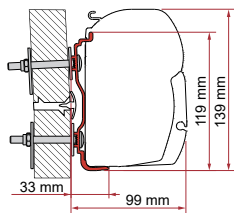

	Quantity / Length	Item No.
Kit Hymer ≥ 2016	3 x 12cm	98655Z059
	Quantity / Length	Item No.
	1 x 300cm	98655Z060
	1 x 350cm	98655Z061
Adapter Hymer ≥ 2016	1 x 400cm	98655Z062
	1 x 450cm	98655Z063
	1 x 500cm	98655Z064

**ADAPTER RAPIDO SERIE 9dF - 9M - 10 ≥ 2011**

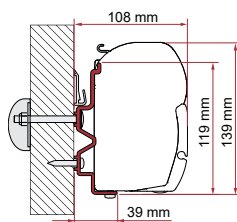

	Quantity / Length	Item No.
Adapter Rapido Serie 9dF - 9M - 10	1 x 350cm	98655-916
	1 x 400cm	98655-917
	1 x 450cm	98655-918

● black finish brackets    \* for right hand drive    \*\* for left and right hand drive

**ADAPTER RAPIDO SERIE 7 - 8**



Fiat 860F  
Fiat Garage 860F,  
870F, 890F

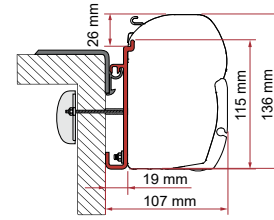

	Quantity / Length	Item No.
Kit Rapido Serie 7-8	2 x 8cm - 1 x 100cm	9865-222

**ADAPTER/KIT RAPIDO SERIE S6 ≥ 2024**

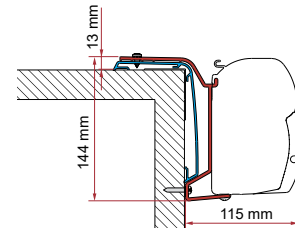

	Quantity / Length	Item No.
Adapter Rapido Serie S6 606F ≥ 2024	1 x 400cm	98655Z173
Adapter Rapido Serie S6 686F ≥ 2024	1 x 450cm	98655Z187
Adapter Rapido Serie S6 666F-696F ≥ 2024	1 x 500cm	98655Z174
Kit Rapido Serie S6 606F ≥ 2024	2 x 12cm + 1 x 8cm	98655Z190
Kit Rapido Serie S6 666F-686F-696F ≥ 2024	2 x 40cm + 1 x 12cm	98655Z191

**ADAPTER RAPIDO SERIE 6**

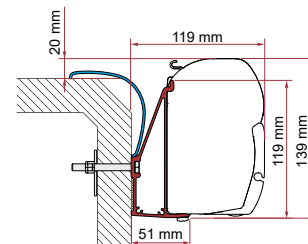

	Quantity / Length	Item No.
Adapter Rapido Serie 6	1 x 350cm	98655-895
	1 x 400cm	98655-896

**KIT RAPIDO SERIE 9**

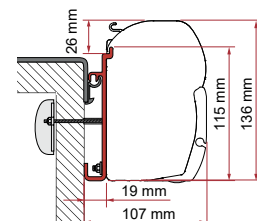

	Quantity / Length	Item No.
Kit Rapido Serie 9	2 x 8cm - 2 x 12cm	98655-223

**KIT ERIBA TOURING**



≤ 06/2013

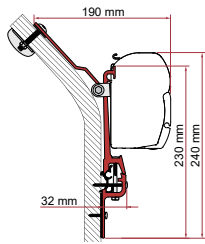

Quantity / Length

Item No.

Kit Eriba Touring

3 x 8cm

98655-283

**KIT BAILEY MK 2**



≥ 2014

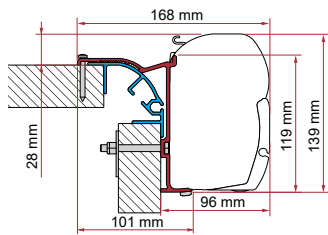

Quantity / Length

Item No.

Kit Bailey MK 2

3 x 15cm

98655-946

**KIT BAILEY MK 1**



≥ 2011 ≤ 2013

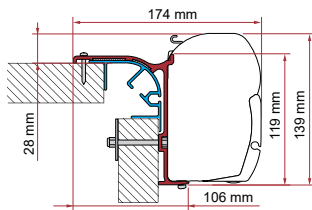

Quantity / Length

Item No.

Kit Bailey MK 1

3 x 15cm

98655-879

**KIT CARAVAN**

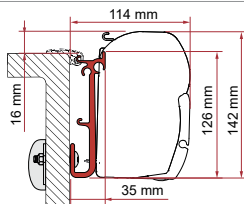

Quantity / Length

Item No.

Kit Caravan

3 x 13cm

98655-252

**KIT FORD TRANSIT**



H2 ≤ 2014  
H3 ≤ 2014

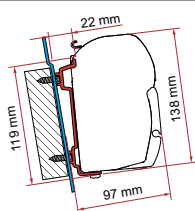

Quantity / Length

Item No.

Kit Ford Transit

2 x 40cm

98655-741

**KIT MULTI**



The only modular bracket fitted to compensate the curved roof of the vehicle. Renault Master 98, Fiat Ducato, Citroën Jumper, Peugeot Boxer

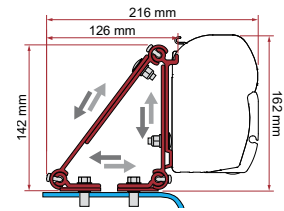

Quantity / Length

Item No.

Kit Multi

1 x 8cm

98655-011

**KIT FIBERGLASS ROOF**

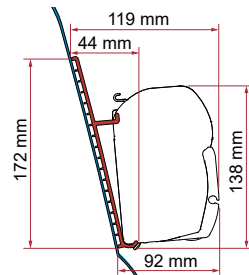

Quantity / Length

Item No.

Kit Fiberglass Roof

2 x 40cm

98655-744

**KIT FORD TRANSIT H3**



L2 / L3 / L4  
MK8 ≥ 2014

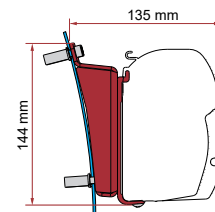

Quantity / Length

Item No.

Kit Ford Transit H3

2 x 25 cm  
1 x 8 cm

98655Z176

\* 98655Z177

**KIT MERCEDES SPRINTER H3 - SPRINTER H3 WESTFALIA - VW CRAFTER H3**



H3

Mercedes / Dodge / Freightliner Sprinter ≥ 2006

VW Crafter I gen. ≥ 2006 ≤ 2016

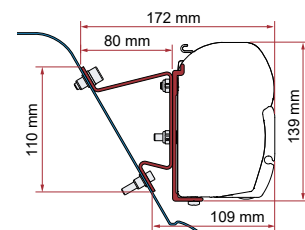

Quantity / Length

Item No.

Kit Mercedes Sprinter H3 - Sprinter H3 Westfalia - VW Crafter H3

3 x 8cm

98655-591

● black finish brackets

\* for right hand drive

\*\* for left and right hand drive



**KIT FIAT DUCATO H2 - CITROËN JUMPER H2 - PEUGEOT BOXER H2**



≥ 1994 ≤ 2006  
H2 - L2/L3

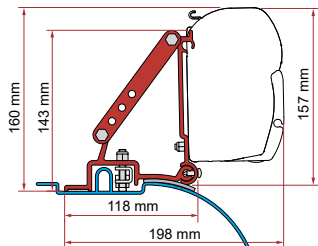

Quantity / Length      Item No.

Kit Fiat Ducato H2  
Citroën Jumper H2  
Peugeot Boxer H2      2 x 8cm      98655-680

**KIT FIAT DUCATO - RENAULT MASTER**



H1/H2

Iveco 35C13 City  
(Fiat New Daily)  
Renault Master ≥ 03/1998

Fiat Ducato  
Peugeot J5  
Citroën C25  
≥ 1981 ≤ 1994

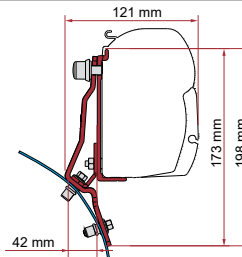

Quantity / Length      Item No.

Kit Fiat Ducato  
Renault Master      2 x 14cm      98655-286

**KIT FIAT DUCATO H2 - CITROËN JUMPER H2 - PEUGEOT BOXER H2**



≥ 2006  
H2 - L2/L3  
H2 - L4 (2x)

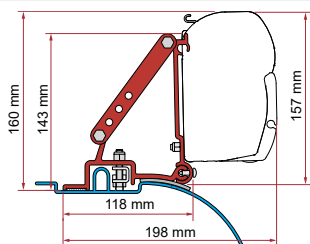

Quantity / Length      Item No.

Kit Fiat Ducato H2  
Citroën Jumper H2  
Peugeot Boxer H2      2 x 8cm      98655-755

**KIT RENAULT MASTER H2 - OPEL MOVANO H2 - NISSAN INTERSTAR H2**



H2 - L2/L3

Renault Master  
≥ 1997 ≤ 2009

Opel Movano  
≥ 1998 ≤ 2010

Nissan Interstar  
≥ 1998 ≤ 2011

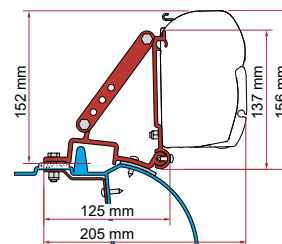

Quantity / Length      Item No.

Kit Renault Master H2 -  
Opel Movano H2 -  
Nissan Interstar H2      3 x 8cm      98655-681

**KIT FIAT DUCATO WITH ROOF RACK**



≥ 2006  
H2 - L2/L3

Citroën Jumper  
Peugeot Boxer  
≥ 2006

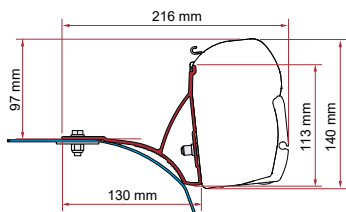

Quantity / Length      Item No.

Kit Fiat Ducato  
with Roof Rack      3 x 12cm      98655-485

**KIT FIAT DUCATO H2 ROOF RAIL - ALU-LINE STYLE**



≥ 2006  
H2 - L2/L3

Citroën Jumper  
Peugeot Boxer  
≥ 2006

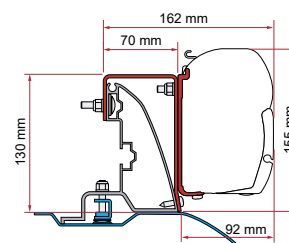

Quantity / Length      Item No.

Kit Fiat Ducato H2 Roof  
Rail Alu-line Style      3 x 12cm      98655-625

**• KIT FIAT DUCATO H2 LIFT ROOF HYMERCAR / PÖSSL LIFT ROOF**



≥ 2006  
H2 - L2/L3/L4

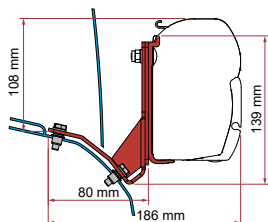

Quantity / Length      Item No.

Kit Fiat Ducato H2 Lift  
Roof- Hymercar  
Pössl Lift Roof      3 x 12cm      98655Z028

**KIT VAN**



For awnings  
up to 3.50m  
long

Both A and B  
brackets  
are delivered  
as standard  
with the kit.

H1-H2  
Peugeot J5  
Citroën C25  
Fiat Ducato ≤ 1994

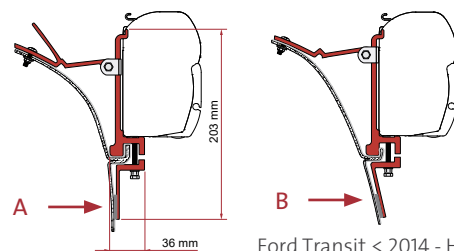

Ford Transit ≤ 2014 - H2  
Mercedes Sprinter 208 D KB

Quantity / Length      Item No.

Kit Van      2 x 8cm      98655-017



# F45s for campervans / F43van

The F45s 260 and 300 awnings and the F43van awning will be equipped with the corresponding standard brackets (in yellow) as standard. The vehicle-specific brackets (in red) will no longer include the standard bracket (standard in the awning).

Dedicated bracket Kit Ford Custom Lift Roof

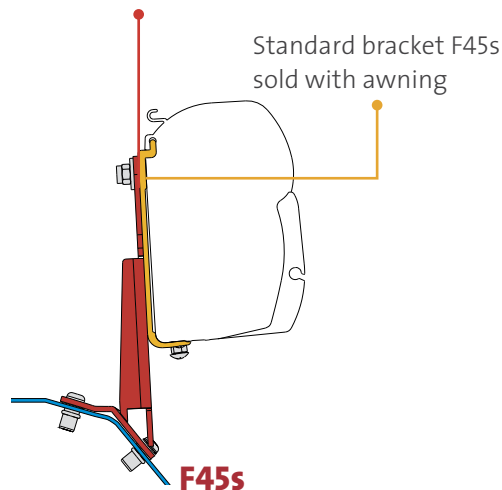

**F45s**

Dedicated bracket Kit Ford Custom Lift Roof

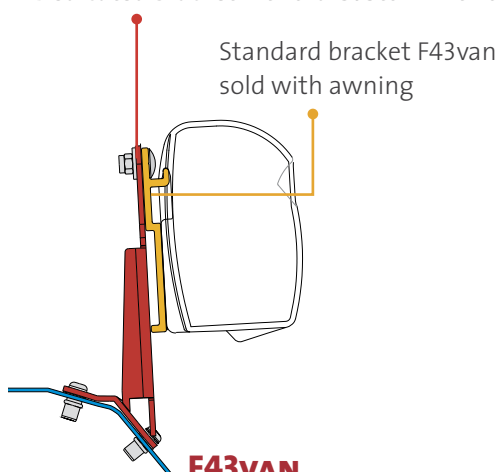

**F43VAN**

	F45	F43	Item Alu	Item Deep Black
Kit Combi Rail Bracket (Rail Brandrup - Vamoose)	●	●	-	98655Z147
Kit VW T5 / T6 California		●	-	98655A712
Kit VW T5 / T6 Multivan Transporter	●		98655-647	98655H647
Kit VW T5 / T6 Multivan Transporter		●	-	98655A647
Kit VW T5 / T6 Multivan Transporter RHD	●		98655-648	98655H648
Kit VW T5 / T6 Multivan Transporter RHD		●	-	98655A648
Kit VW T5/T6 Multivan with Rail		●	-	98655A686
Kit VW T5/T6 Multivan with Rail - RHD		●	-	98655A739
Kit VW T5/T6 Lift Roof	●		-	98655Z159
Kit VW T5/T6 Lift Roof		●	-	98655A159
Kit VW T5/T6 Lift Roof - RHD	●		-	98655Z160
Kit VW T5/T6 Lift Roof - RHD		●	-	98655A160
Kit VW T5 / T6 Multirail Reimo	●	●	-	98655Z156
Kit Brandrup VW T4	●	●	98655Z011	-
Kit VW T4 / Lift Roof	●		-	98655-292
Kit VW T3	●	●	-	98655-035
Kit PSA		●	-	98655A090
Kit Ford Custom / Lift Roof	●	●	-	98655Z169
Kit Ford Custom / Lift Roof - RHD	●	●	-	98655Z170
Kit V Class Marco Polo	●	●	-	98655Z022
Kit Renault Trafic - Opel Vivaro - Nissan Primastar	●		98655-854	-
Kit Renault Trafic - Opel Vivaro - Nissan Primastar		●	-	98655A854
Kit Renault Trafic - Opel Vivaro - Nissan NV300 - Fiat Talento	●		98655Z021	-
Kit Renault Trafic - Opel Vivaro - Nissan NV300 - Fiat Talento		●	-	98655A021
Kit Ford Transit Nugget High Roof	●		98655Z023	-
Kit Ford Custom Nugget Lift Roof	●	●	-	98655Z114
Kit Auto	●	●	98655-310	-
Kit Roof Rail	●	●	-	98655-770
Kit High Roof Adapter Westfalia	●		98655-317	-
Kit Mercedes Vito	●	●	-	98655-284

● **KIT COMBI RAIL BRACKET**



≥ 2003 H1 - L1  
VW T5 / T6 Transporter / Caravelle / Multivan  
Also for models with lift roof

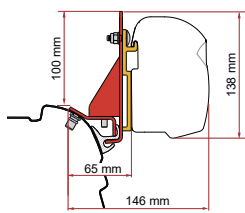
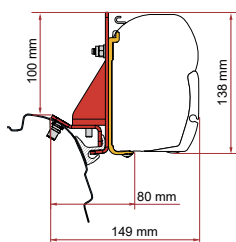

Quantity / Length      Item No.

Kit Combi Rail Bracket  
(Rail Brandrup - Vamoose)

2 x 8cm

●● 98655Z147

● black finish brackets

● for right hand drive

●● for left and right hand drive

**KIT VW T5 / T6 MULTIVAN TRANSPORTER**



≥ 2003  
H1 - L1

VW T5 / T6  
Transporter /  
Caravelle /  
Multivan  
Without  
"C" roof rail

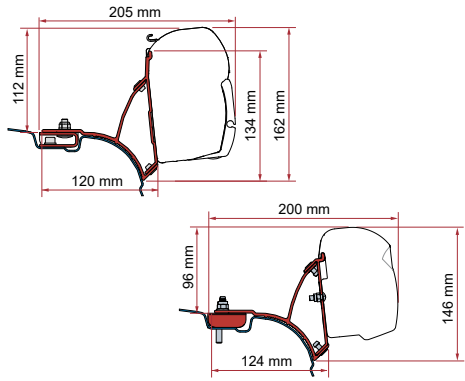

F45s	Quantity / Length	Item No.
Kit VW T5 / T6 Multivan Transporter	2 x 21,5 cm	98655-647 ● 98655H647 * 98655-648 ** 98655H648
F43van	Quantity / Length	Item No.
Kit VW T5 / T6 Multivan Transporter	2 x 21,5 cm	● 98655A647 ** 98655A648

**● KIT VW T5 / T6 MULTIRAIL REIMO**



≥ 2003  
H1 - L1

VW T5 / T6  
Transporter /  
Caravelle /  
Multivan

Also for  
models with  
lift roof

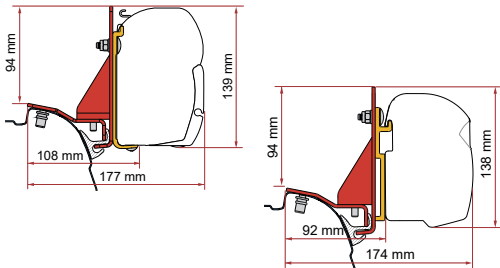

	Quantity / Length	Item No.
Kit VW T5 / T6 Multirail Reimo	2 x 8cm	** 98655Z156

**KIT VW T4 - VW T4 LIFT ROOF**



≥ 1990 ≤ 2003  
H1 - L1/L2

Also for  
models with  
lift roof

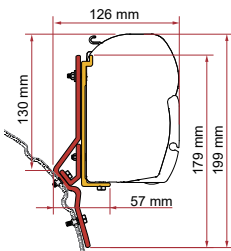

	Quantity / Length	Item No.
Kit VW T4 - VW T4 Lift Roof	2 x 14cm	98655-292

**● KIT VW T5 / T6 LIFT ROOF**



H1  
L1 / L2

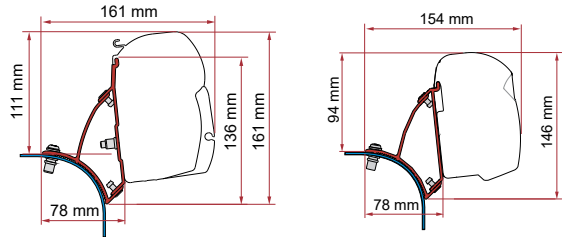

F45s	Quantity / Length	Item No.
Kit VW T5/T6 Lift Roof	2 x 21,5 cm	98655Z159 * 98655Z160
F43van	Quantity / Length	Item No.
Kit VW T5/T6 Lift Roof	2 x 21,5 cm	98655A159 * 98655A160

**● KIT VW T5 / T6 CALIFORNIA**

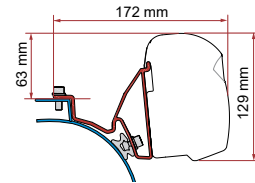

F43van	Quantity / Length	Item No.
Kit VW T5/T6 California	2 x 12 cm	98655A712

**● KIT VW T5 / T6 MULTIVAN WITH RAIL**



H1 - L1/L2

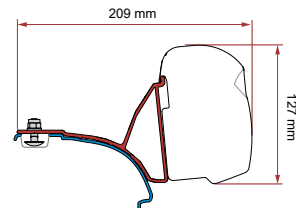

F43van	Quantity / Length	Item No.
Kit VW T5/T6 Multivan with Rail	1 x 12 cm 1 x 21,5 cm	98655A686 * 98655A739

**KIT VW T4 BRANDRUP**



≥ 1990 ≤ 2003  
H1 - L1/L2

Reimo  
Multirail

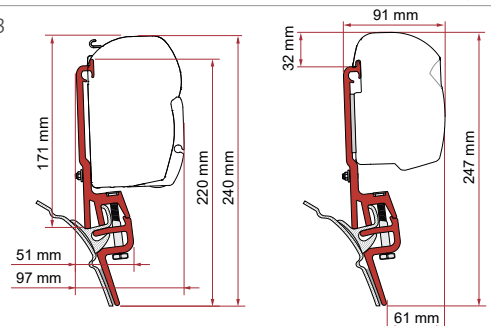

	Quantity / Length	Item No.
Kit Brandrup VW T4	2 x 8cm	98655Z011

● black finish brackets    \* for right hand drive    \*\* for left and right hand drive



• **KIT VW T3**



≥ 1979 ≤ 1990  
H1

Also for models with lift roof

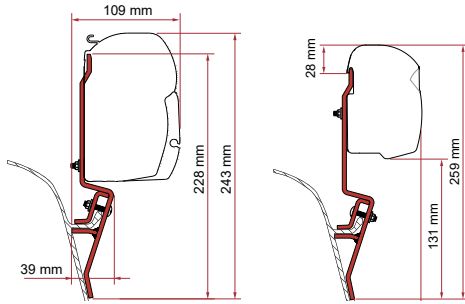

Quantity / Length      Item No.

Kit VW T3      2 x 8cm      98655-035

• **KIT FORD CUSTOM / LIFT ROOF**



Attention: opening/closing operations of the awning must be performed with the sliding door closed.

≥ 2012 ≤ 2023  
H1  
L1 / L2

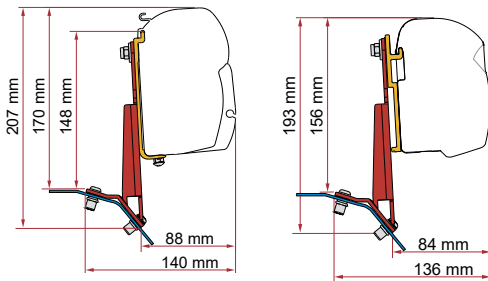

Quantity / Length      Item No.

Kit Ford Custom Lift Roof      2 x 12cm      98655Z169  
\* 98655Z170

**KIT RENAULT TRAFIC - OPEL VIVARO - NISSAN PRIMASTAR**



≥ 2001 ≤ 2014

F45s (230/270) - H1 - L1/L2  
F43van (270) - H1 - L2

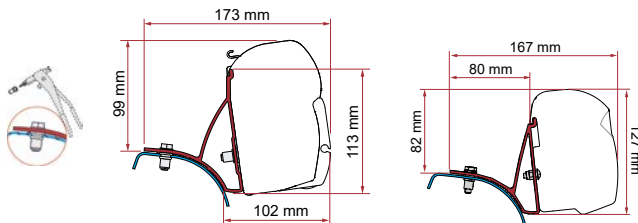

F45s      Quantity / Length      Item No.

Kit Renault Traffic - Opel Vivaro - Nissan Primastar      2 x 16 cm      98655-854

F43van      Quantity / Length      Item No.

Kit Renault Traffic - Opel Vivaro - Nissan Primastar      2 x 16 cm      98655A854

• **KIT PSA**



H1 - L1

Citroën Jumpy III, Spacetourer ≥ 2016  
Opel / Vauxhall Vivaro C, Zafira Life ≥ 2019  
Peugeot Expert III, Traveller ≥ 2016  
Toyota Proace II, Proace Verso ≥ 2016

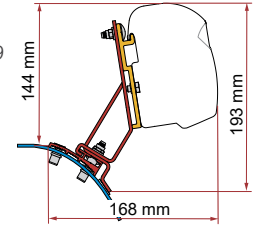

F43van      Quantity / Length      Item No.

Kit PSA      2 x 20 cm      98655A090

**KIT V CLASS MARCO POLO**



≥ 2014  
H1 - L2  
Not suitable for Marco Polo with electric roof

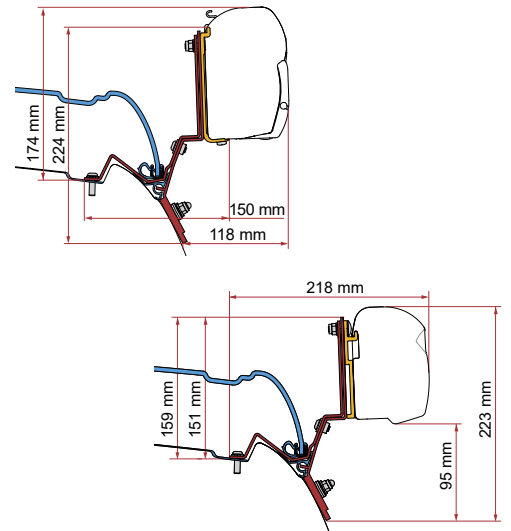

Quantity / Length      Item No.

Kit V Class Marco Polo      1 x 12cm - 1 x 13cm      98655Z022

**KIT RENAULT TRAFIC - OPEL VIVARO - NISSAN NV300 - FIAT TALENTO**



≥ 2014  
F45s (230/270) - H1 - L1/L2  
F43van (270) - H1 - L2

Opel Vivaro B  
Vauxhall Vivaro B  
≥ 2014 ≤ 2018

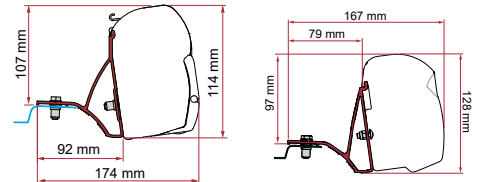

F45s      Quantity / Length      Item No.

Kit Renault Traffic - Opel Vivaro - Nissan NV300 - Fiat Talento      2 x 16 cm      98655Z021

F43van      Quantity / Length      Item No.

Kit Renault Traffic - Opel Vivaro - Nissan NV300 - Fiat Talento      2 x 16 cm      98655A021

• black finish brackets

\* for right hand drive

\*\* for left and right hand drive

**KIT FORD CUSTOM NUGGET HIGH ROOF**



≥ 2012 ≤ 2023  
H2 - L2

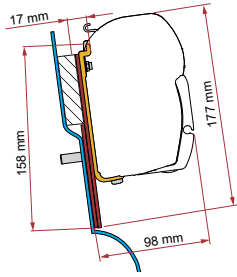

Quantity / Length      Item No.

Kit Ford Custom Nugget  
- High Roof

2 x 12cm

98655Z023

**• KIT FORD CUSTOM NUGGET LIFT ROOF**



≥ 2015 ≤ 2023  
H1 - L1

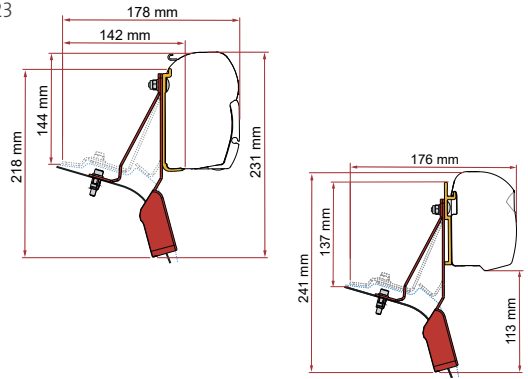

Quantity / Length      Item No.

Kit Ford Custom Nugget  
Lift Roof

2 x 8cm

98655Z114

**KIT AUTO**

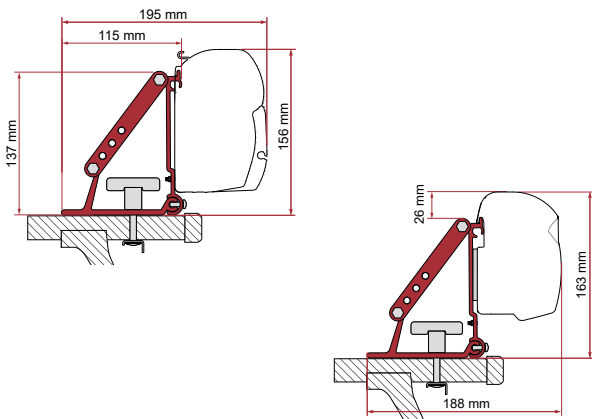

Quantity / Length      Item No.

Kit Auto

2 x 8cm

98655-310

**KIT ROOF RAIL**



Rail max width 5,5cm  
Min. 2 Kits to install an awning

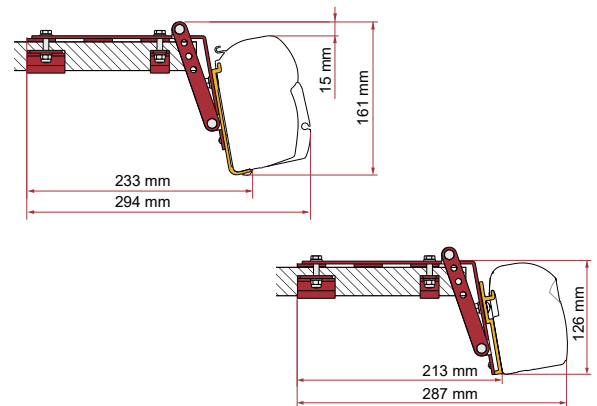

Quantity / Length      Item No.

Kit Roof Rail

1 x 12cm

98655-770

**KIT HIGH ROOF ADAPTER WESTFALIA**

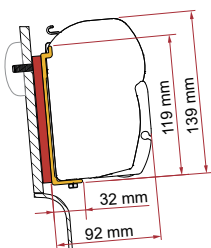

Quantity / Length      Item No.

Kit High Roof  
Adapter Westfalia

2 x 12cm

98655-317

**KIT MERCEDES VITO**



≥ 1996 ≤ 2003  
H1 - L1

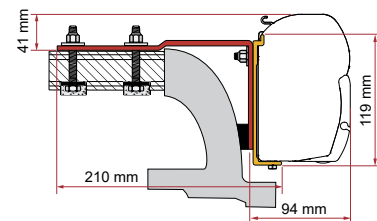

Quantity / Length      Item No.

Kit Mercedes Vito

2 x 14cm

98655-284

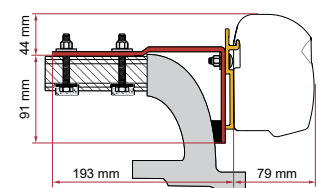

- black finish brackets
- \* for right hand drive
- \*\* for left and right hand drive



# F80

## KIT STANDARD

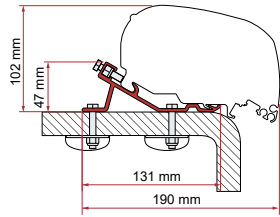

Quantity / Length      Item No.

Kit Standard      3 x 20cm      98655-855

## KIT GIOTLINE - FENDT



For Genetics / Graal

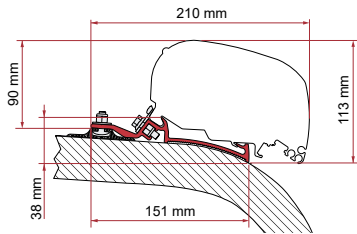

Quantity / Length      Item No.

Kit Giottline - Fendt      3 x 15cm      98655-725

## KIT / ADAPTER LAIKA ECOVIP / REXOSLINE / KREOS

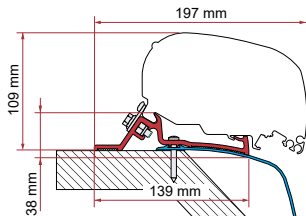

Quantity / Length      Item No.

Adapter Laika Ecovip / Rexosline / Kreos >09 <21      1 x 500 cm      98655Z168

Kit Laika Rexosline / Kreos 09      4 x 15 cm      98655-419

## ADAPTER STANDARD F65EAGLE 400

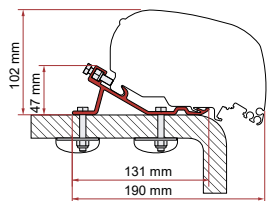

Quantity / Length      Item No.

Adapter Standard F65eagle 400      1 x 400cm      98655-969

## KIT LAIKA KREOS 2005

≥ 2005 ≤ 2008

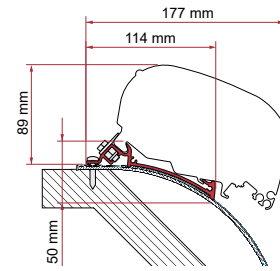

Quantity / Length      Item No.

Kit Laika Kreos 05      3 x 15cm      98655-698

## KIT LAIKA KREOS > 2021



≥ 2021

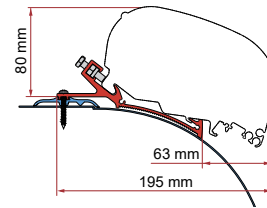

Quantity / Length      Item No.

Kit Laika Kreos 21      4 x 15cm      98655Z119

## KIT ARCA MOBILVETTA K-YACHT



≤ 2021



Quantity / Length      Item No.

Kit Arca Mobilvetta K-Yacht      3 x 15cm      98655Z079

## ADAPTER CARTHAGO CHIC RAPIDO 180 - 190



≤ 2014

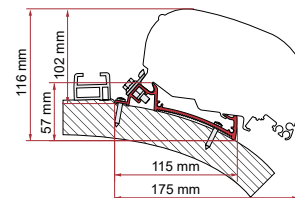

Quantity / Length      Item No.

1 x 340cm      98655Z135

1 x 400cm      98655-736

Adapter Carthago Chic Rapido i80 - i90      1 x 450cm      98655-737

1 x 490cm      98655-738

1 x 550cm      98655Z130

● black finish brackets

\* for right hand drive

\*\* for left and right hand drive



**ADAPTER RAPIDO DISTINCTION**

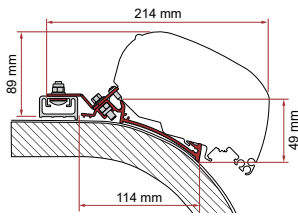

	Quantity / Length	Item No.
Adapter Rapido Distinction	1 x 400cm	98655Z080
	1 x 450cm	98655Z081
	1 x 490cm	98655Z082
	1 x 600cm	98655Z125

**ADAPTER LMC - TEC**

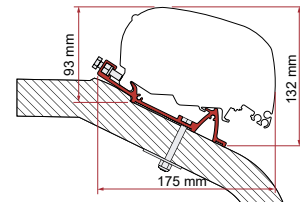

	Quantity / Length	Item No.
Adapter LMC - TEC	1 x 290cm	98655-773
	1 x 340cm	98655-774
	1 x 370cm	98655-775
	1 x 400cm	98655-776
	1 x 450cm	98655Z126
	1 x 500cm	98655Z127
	1 x 550cm	98655Z128
	1 x 600cm	98655Z129

**ADAPTER RAPIDO C LINE**



Rapido C86, C56, C55, C50

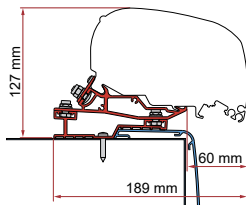

	Quantity / Length	Item No.
Adapter Rapido C Line	340cm - C56	98655Z120
	400cm - C50	98655Z121
	425cm - C55	98655Z122
	450cm - C86	98655Z123

**ADAPTER CARTHAGO MALIBU**

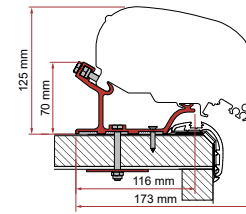

	Quantity / Length	Item No.
Adapter Carthago Malibu	1 x 340cm	98655Z083
	1 x 400cm	98655Z084
	1 x 450cm	98655Z085
	1 x 490cm	98655Z086

**ADAPTER RAPIDO C55i C86i**

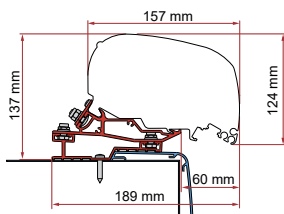

	Quantity / Length	Item No.
Adapter Rapido C55i C86i	1 x 500cm	98655Z138

**ADAPTER HYMER**

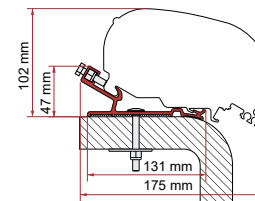

	Quantity / Length	Item No.
Adapter Hymer	1 x 290cm	98655-932
	1 x 320cm	98655-933
	1 x 340cm	98655-934
	1 x 370cm	98655-935
	1 x 400cm	98655-936
	1 x 450cm	98655-937
	1 x 490cm	98655-938
	1 x 550cm	98655Z132
	1 x 600cm	98655Z133

**KIT AUTOCRUISE**

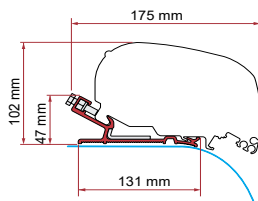

	Quantity / Length	Item No.
Kit Autocruise	3 x 15cm	98655-420

- black finish brackets
- \* for right hand drive
- \*\* for left and right hand drive

**KIT FIXING BAR**



Only for use with Fixing Bar Pro L (98655-295)

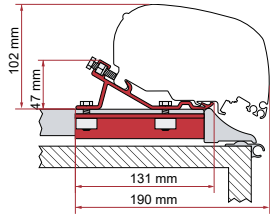

Quantity / Length      Item No.

Kit Fixing Bar	3 x 20cm	98655-384
----------------	----------	-----------

**KIT LMC ADAPTER CARAVAN ROOF**



Kit consisting of 4 plates, screws & nuts enabling the installation of the F80s awning to LMC caravans using the Kit or Adapter Caravan Roof

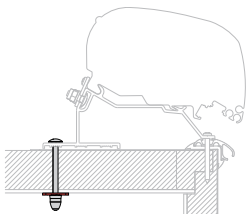

Quantity      Item No.

Kit LMC Adapter Caravan Roof	4 plates, screws & nuts	98655Z100
------------------------------	-------------------------	-----------

**ADAPTER / KIT ADRIA CARAVAN**



≥ 2015

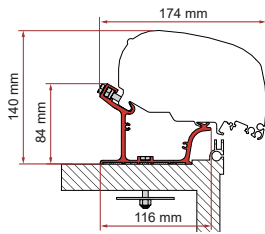

\* without drilling

Quantity / Length      Item No.

Kit Adria Caravan	2 x 50cm + 2 x 27cm	98655Z140
Adapter Adria Caravan 450 *	450cm	98655Z141
Adapter Adria Caravan 500 *	500cm	98655Z142
Adapter Adria Caravan 550 *	550cm	98655Z143
Adapter Adria Caravan 600 *	600cm	98655Z144

**KIT HOBBY EXCELLENT**

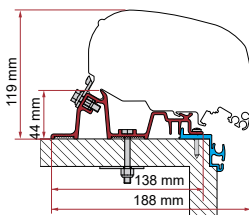

Quantity / Length      Item No.

Kit Hobby Excellent	2 x 50cm - 2 x 30cm	98655-662
---------------------	---------------------	-----------

**KIT / ADAPTER CARAVAN ROOF**



Dehleffs / Fendt / LMC / Trigano

Kit and adapters equipped with aluminum finishing kit as standard

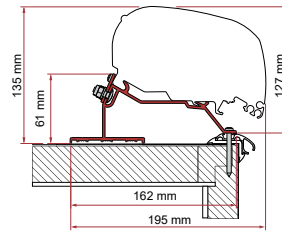

Quantity / Length      Item No.

Adapter Caravan Roof	1 x 290cm	98655Z067
	1 x 320cm	98655Z068
	1 x 340cm	98655Z069
	1 x 370cm	98655Z070
	1 x 400cm	98655Z071
	1 x 425cm	98655Z072
	1 x 450cm	98655Z073
	1 x 500cm	98655Z074
	1 x 550cm	98655Z075
	1 x 600cm	98655Z076

Quantity / Length      Item No.

Kit Caravan Roof	3 x 100cm	98655Z066
------------------	-----------	-----------

**KIT BAILEY**

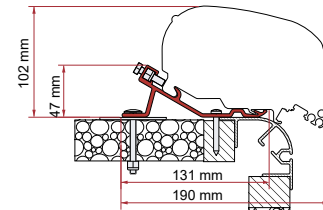

Quantity / Length      Item No.

Kit Bailey	3 x 25cm	98655-939
------------	----------	-----------

**KIT HOBBY EASY / ONTOUR / ADRIA ADORA**

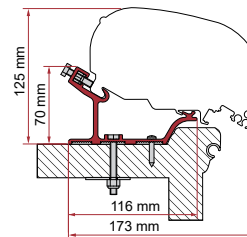

Quantity / Length      Item No.

Kit Hobby Easy / Ontour / Adria Adora	2 x 50cm - 2 x 30cm	98655-949
---------------------------------------	---------------------	-----------

● black finish brackets

\* for right hand drive

\*\* for left and right hand drive

**ADAPTER CARAVAN STANDARD**

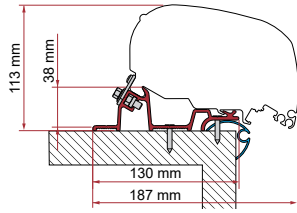

	Quantity / Length	Item No.
Adapter Caravan Standard 320	1 x 320cm	98655Z178
Adapter Caravan Standard 340	1 x 340cm	98655Z179
Adapter Caravan Standard 370	1 x 370cm	98655Z180
Adapter Caravan Standard 400	1 x 400cm	98655Z181
Adapter Caravan Standard 425	1 x 425cm	98655Z182
Adapter Caravan Standard 450	1 x 450cm	98655Z183
Adapter Caravan Standard 500	1 x 500cm	98655Z184
Adapter Caravan Standard 550	1 x 550cm	98655Z185
Adapter Caravan Standard 600	1 x 600cm	98655Z186

**KIT CARAVAN STANDARD**

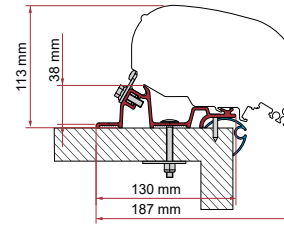

	Quantity / Length	Item No.
Kit Caravan Standard	2 x 50cm - 2 x 30cm	98655-657

**KIT HOBBY CARAVAN**



≥ 2014

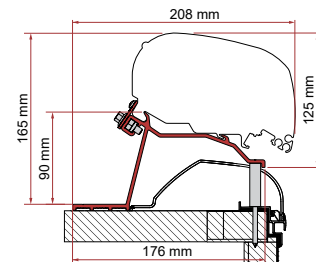

	Quantity / Length	Item No.
Kit Hobby Caravan	2 x 27cm - 2 x 60cm	98655Z065

**KIT HOBBY PREMIUM & ONTOUR**



≥ 2012

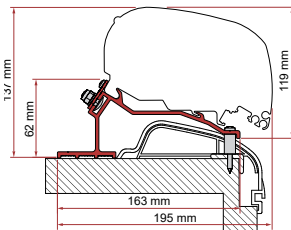

	Quantity / Length	Item No.
Kit Hobby Premium & Outour	2 x 25cm - 2 x 50cm	98655Z089

**KIT HOBBY PREMIUM**

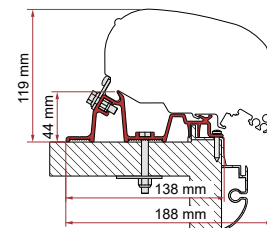

	Quantity / Length	Item No.
Kit Hobby Premium	2 x 50cm - 2 x 30cm	98655-628

**KIT HOBBY CARAVAN**



≥ 2009

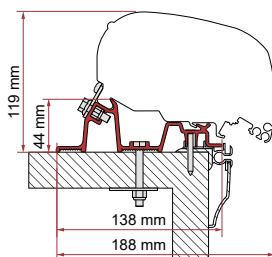

	Quantity / Length	Item No.
Kit Hobby Caravan	2 x 50cm - 2 x 30cm	98655-921

**ADAPTER FORD TRANSIT H3**



Check the position of the antenna on the vehicle before purchase and installation

≥ 2014

L3 - L4

MK8

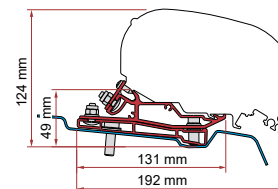

	Quantity / Length	Item No.
Adapter Ford Transit L3 H3	1 x 320 cm	98655Z145
	1 x 320 cm	* 98655Z163
Adapter Ford Transit L4 H3	1 x 400 cm	98655Z108
	1 x 400 cm	* 98655Z164

● black finish brackets      \* for right hand drive      \*\* for left and right hand drive



**ADAPTER FORD TRANSIT VAN H2**



L2 - L3

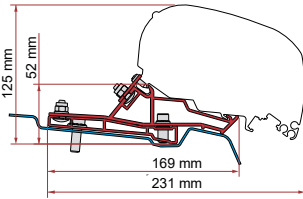

Quantity / Length      Item No.

Adapter Ford Transit - H2 L2	1 x 290cm	98655Z166
Adapter Ford Transit - H2 L3	1 x 340cm	98655Z167
Adapter Ford Transit - H2 L2	1 x 290cm	* 98655Z188
Adapter Ford Transit - H2 L3	1 x 340cm	* 98655Z189

**\*\* KIT DUCATO H2 SKYROOF**



bracket required if the vehicle is equipped with a panoramic rooflight

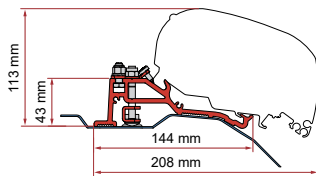

Quantity / Length      Item No.

Kit Ducato H2 Skyroof	3 x 35cm	98655Z139
-----------------------	----------	-----------

**\*\* KIT SMART CLAMP DUCATO**



≥ 2006  
H2 - L2 / L3 / L4  
F80s

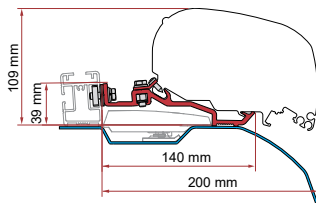

Quantity / Length      Item No.

Kit Smart Clamp Ducato	2 x 20cm - 2 x 12cm	98655Z097
------------------------	------------------------	-----------

**\*\* KIT FIAT DUCATO / CITROËN JUMPER / PEUGEOT BOXER**



Brackets complete with Rain Guard Slim Kit 450cm and Cover Kit  
Not suitable for vehicles with front panoramic rooflight

≥ 2006  
H2 - L2 / L3  
Low profile  
Only for F80s

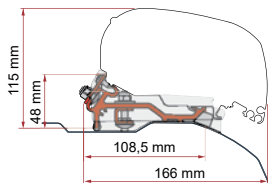

Quantity / Length      Item No.

Kit Fiat Ducato / Citroën Jumper / Peugeot Boxer Low Profile	1 x 20cm - 1 x 15cm - 1 x 12cm	98655Z149 ● 98655Z150
--	--------------------------------------	--------------------------

**\*\* KIT FIAT DUCATO / CITROËN JUMPER / PEUGEOT BOXER - H2**



Brackets complete with Rain Guard Slim Kit 450cm and Cover Kit  
Not suitable for vehicles with front panoramic rooflight

≥ 2006  
H2 - L4  
Low profile  
Only for F80s

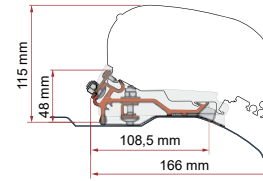

Quantity / Length      Item No.

Kit Fiat Ducato / Citroën Jumper / Peugeot Boxer Low Profile	2 x 26cm - 1 x 12cm	98655Z148
--	------------------------	-----------

**\*\* KIT FIAT DUCATO / CITROËN JUMPER / PEUGEOT BOXER - H2**



Before installation, check compatibility with the front panoramic rooflight. Brackets equipped with Kit Rain Guard 300cm

≥ 2006  
H2 - L2 / L3  
For F80s and F65s

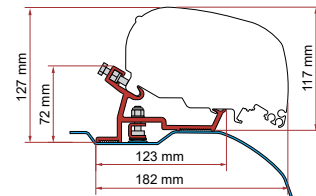

Quantity / Length      Item No.

Kit Fiat Ducato / Citroën Jumper / Peugeot Boxer	1 x 20cm - 1 x 15cm - 1 x 12cm	98655Z101 ● 98655Z102
--	--------------------------------------	--------------------------

**\*\* KIT FIAT DUCATO / CITROËN JUMPER / PEUGEOT BOXER - H2**



Before installation, check compatibility with the front panoramic rooflight. Brackets equipped with Kit Rain Guard 400cm

≥ 2006  
H2 - L4  
For F80s and F65s

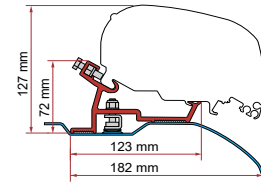

Quantity / Length      Item No.

Kit Fiat Ducato / Jumper / Boxer - H2	2 x 26cm - 1 x 12cm	98655-904
---------------------------------------	------------------------	-----------

**KIT FIAT DUCATO / CITROËN JUMPER / PEUGEOT BOXER - H3**



≥ 2006  
H3 - L3 / L4

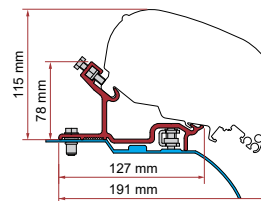

Quantity / Length      Item No.

Kit Fiat Ducato / Citroën Jumper / Peugeot Boxer - H3	1 x 20cm - 1 x 25cm - 1 x 35cm	98655-656
---	--------------------------------------	-----------

● black finish brackets

\* for right hand drive

\*\* for left and right hand drive

**KIT FIAT DUCATO / CITROËN JUMPER / PEUGEOT BOXER H2 - ≤ 06**



≥ 1994 ≤ 2006  
H2 - L2 / L3  
High profile bracket

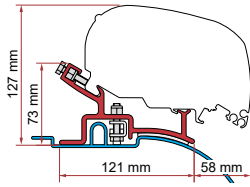

Quantity / Length      Item No.

Kit Fiat Ducato / Citroën Jumper / Peugeot Boxer - H2 - ≤ 2006	2 x 20cm	98655-373
--	----------	-----------

**KIT FIAT DUCATO / CITROËN JUMPER / PEUGEOT BOXER H2 - ≤ 06**



≥ 1994 ≤ 2006  
H2 - L2 / L3  
Low profile bracket

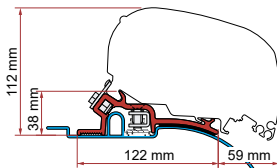

Quantity / Length      Item No.

Kit Fiat Ducato / Citroën Jumper / Peugeot Boxer - H2 - ≤ 2006	2 x 20cm	98655-693
--	----------	-----------

**ADAPTER SPRINTER F65EAGLE**



Sprinter ≥ 2006  
VW Crafter  
≥ 2006 ≤ 2016

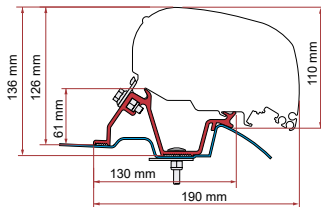

Quantity / Length      Item No.

Adapter Sprinter F65eagle	1 x 400cm	98655-768 * 98655Z010
---------------------------	-----------	--------------------------

**KIT RENAULT MASTER H2**



≥ 1997 ≤ 2009  
H2 - L2 / L3

Also for  
Opel Movano  
≥ 1998 ≤ 2010  
Nissan Interstar  
≥ 1998 ≤ 2011

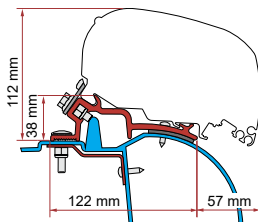

Quantity / Length      Item No.

Kit Renault Master H2	2 x 29cm - 1 x 12cm	98655-468
-----------------------	------------------------	-----------

**KIT MERCEDES SPRINTER - ROOF RAIL**



with Roof Rail  
≥ 2006 ≤ 2016 - H2 - L2/L3/L4  
Mercedes Sprinter/ VW Crafter/ Freightliner Sprinter/Dodge Sprinter  
≥ 2016 - H2 - L1/L2/L3/L4  
Mercedes Sprinter/ Freightliner Sprinter/Dodge Sprinter

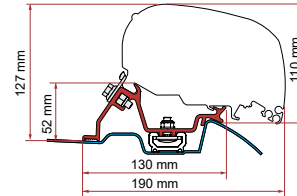

Quantity / Length      Item No.

Kit Mercedes Sprinter with Roof Rail	2 x 40cm - 1 x 12cm	98655-772
--------------------------------------	------------------------	-----------

**KIT MERCEDES SPRINTER / VW CRAFTER HIGH ROOF**



≥ 2006 ≤ 2016 - H2 - L2/L3/L4  
Mercedes Sprinter/ VW Crafter/ Dodge Sprinter/ Freightliner Sprinter  
≥ 2016 - H2 - L1/L2/L3/L4  
Mercedes Sprinter/ Dodge Sprinter/ Freightliner Sprinter

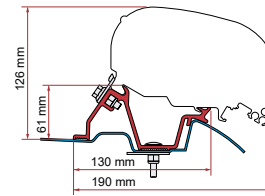

Quantity / Length      Item No.

Kit Mercedes Sprinter / VW Crafter High Roof	1 x 12cm - 1 x 53cm - 1 x 60cm	98655-746 * 98655-889
--	--------------------------------------	--------------------------

**KIT IVECO DAILY H2**



≥ 2006 ≤ 2014  
H2 - L2/L3

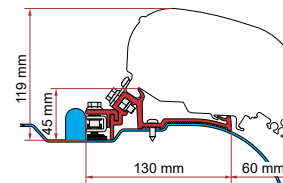

Quantity / Length      Item No.

Kit Iveco Daily H2	2 x 15cm - 1 x 20cm	98655-733
--------------------	------------------------	-----------

**\*\* KIT RENAULT MASTER H2 ≥ 2010**



≥ 2010 - H2 - L2 / L3  
Also for Opel Movano and Nissan NV400

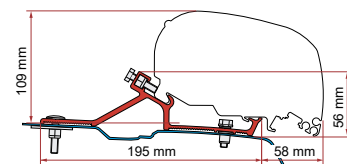

Quantity / Length      Item No.

Kit Renault Master ≥ 2010	1 x 12cm - 1 x 44cm - 1 x 64cm	98655-881
---------------------------	--------------------------------------	-----------

● black finish brackets      \* for right hand drive      \*\* for left and right hand drive

**KIT VW CRAFTER - ROOF RAIL**



with Roof Rail

≥ 2017  
H3 - L3/L4

Man Tge

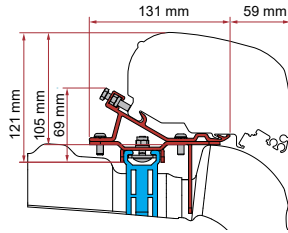

Quantity / Length

Item No.

Kit VW Crafter  
with Roof Rail

1 x 20cm -  
1 x 30cm -  
1 x 40cm

98655Z036

**• KIT VW CRAFTER H3**



For VW Crafter L3/H3 pls choose the F80s 320cm long  
For VW Crafter L4/H3 pls choose the F80s 400cm long

≥ 2017

Man Tge

Without  
Roof Rail

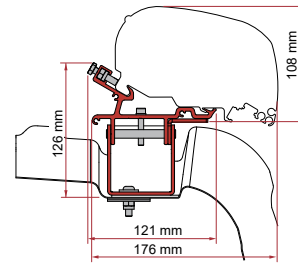

Quantity / Length

Item No.

Kit VW Crafter H3

2 x 20cm -  
1 x 32cm

98655Z043

\* 98655Z058

**F40van**

**• ADAPTER PSA**



H1 - L = 4956/9 mm

Opel Vivaro C / Opel Zafira Life / Vauxhall Vivaro Life ≥ 2019  
Citroën Jumpy III gen. / Spacetourer / Peugeot Traveller / Peugeot  
Expert III gen. / Toyota ProAce II / Toyota ProAce Verso ≥ 2016

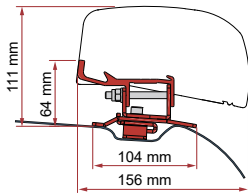

Quantity / Length

Item No.

Adapter PSA

1 x 260cm

98655Z110

**• KIT RENAULT TRAFIC L1**



≥ 2014 - H1 - L1

Nissan NV 300 / Fiat Talento ≥ 2014

Opel Vivaro-Vauxhall Vivaro B ≥ 2014 ≤ 2018

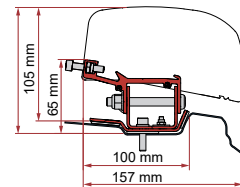

Quantity / Length

Item No.

Kit Renault Trafic L1

2 x 26cm

\*\* 98655Z087

**• KIT RENAULT TRAFIC L2**



≥ 2014 - H1 - L2

Nissan NV 300 / Fiat Talento ≥ 2014

Opel Vivaro-Vauxhall Vivaro B ≥ 2014 ≤ 2018

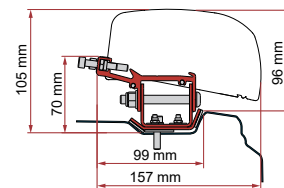

Quantity / Length

Item No.

Kit Renault Trafic L2

2 x 26 cm

\*\* 98655Z088

**• KIT MERCEDES V CLASS**



≥ 2014

H1 - L2

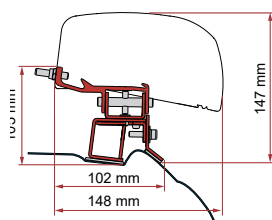

Quantity / Length

Item No.

Kit Mercedes  
V Class

1 x 39cm - 1 x 22cm

98655Z078

**• KIT VW T5 / T6 RAIL**



L1 / L2

with standard rail

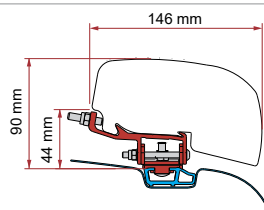

Quantity /  
Length

Item No.

Kit VW T6

2x 20cm \*\* 98655Z165

**• KIT VW T5 / T6**



≥ 2003 - H1 - L1/L2

VW T5 / T6 Transporter / Caravelle / Multivan

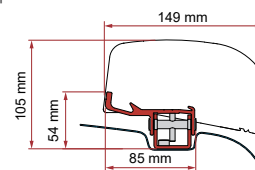

Quantity / Length

Item No.

Kit VW T5 / T6

1 x 20 cm  
1 x 25 cm

98655Z152

\* 98655Z153

• black finish brackets

\* for right hand drive

\*\* for left and right hand drive



● **KIT FORD CUSTOM L1**



≥ 2012 ≤ 2023  
H1 - L1

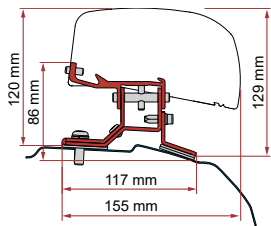

Quantity / Length

Item No.

Kit Ford Custom L1

1 x 45,5cm -  
1 x 20cm

98655Z044  
\* 98655Z046

● **KIT FORD CUSTOM L2**



≥ 2012 ≤ 2023  
H1 - L2

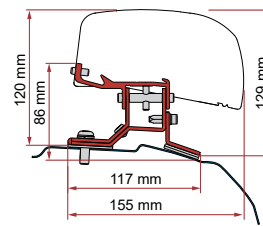

Quantity / Length

Item No.

Kit Ford Custom L2

1 x 22,5cm - 1 x 20cm \*\* 98655Z045

● **KIT NV350**



≥ 2012 - H1 - L2  
Nissan Impendulo / Isuzu Como / Mitsubishi Fuso Canter Van ≥ 2012

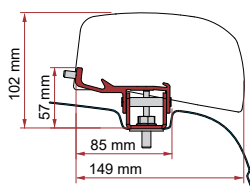

Quantity / Length

Item No.

Kit NV350 [Restyling]

1 x 20cm - 1 x 25cm \* 98655Z194

● **KIT NV200**



Only for  
F40van 210

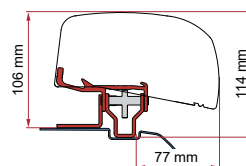

Quantity / Length

Item No.

Kit NV200 [Restyling]

2 x 25cm  
1 x 10cm

98655Z193

# F35pro

● **KIT CAMPÉRÈVE CAP ROAD**



≥ 2016  
H1 - L = 4959 mm

Only on Rapido Autocaravan Campérève Cap Road based on Peugeot Expert III gen.

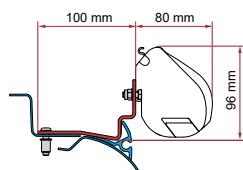

Quantity / Length

Item No.

Kit Campérève Cap Road

2 x 12cm \*\* 98655Z151

● **KIT PSA**



H1- L = 4956/9 mm

Opel Vivaro C / Opel Zafira Life / Vauxhall Vivaro Life ≥ 2019  
Citroën Jumpy III gen. / Spacetourer / Peugeot Traveller Peugeot Expert III gen. Toyota ProAce II / Toyota ProAce Verso ≥ 2016

Also for models  
with lift roof

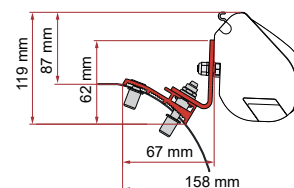

Quantity / Length

Item No.

Kit PSA

2 x 20cm \*\* 98655Z095

● **KIT VW CADDY MAXI**



≥ 2016  
H1 - L1

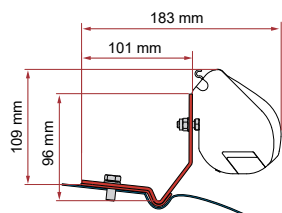

Quantity / Length

Item No.

Kit VW Caddy Maxi

2 x 8cm \*\* 98655Z096

● **KIT VW CADDY MAXI LIFT ROOF**



≥ 2016  
H1 - L1

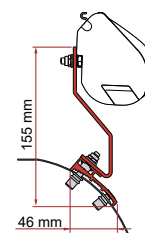

Quantity / Length

Item No.

Kit VW Caddy Maxi Lift Roof

2 x 12cm \*\* 98655Z109

● black finish brackets    \* for right hand drive    \*\* for left and right hand drive

● **KIT VW T5 / T6 MULTIRAIL REIMO**



Also for models with lift roof

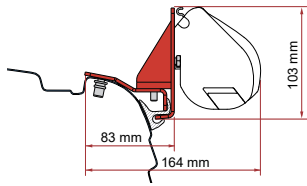

Quantity / Length      Item No.

Kit VW T5 / T6 Multirail Reimo      2 x 8cm      \*\* 98655Z155

● **KIT VW T6 KEPLER**



≥ 2014  
H1- L2

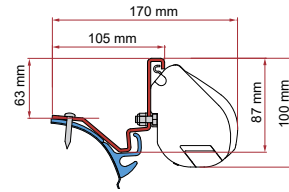

Quantity / Length      Item No.

Kit VW T6 Kepler      2 x 10cm      98655Z033

**KIT VW T5 / T6 MULTIVAN TRANSPORTER**



≥ 2003 - H1 - L1  
VW T5 / T6 Transporter / Caravelle / Multivan

Without  
"C" roof rail

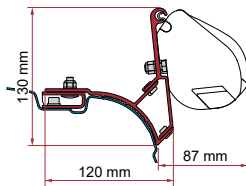

Quantity / Length      Item No.

Kit VW T5 / T6 Multivan Transporter      2 x 21,5cm      \* 98655Z005



**KIT VW T5 / T6 MULTIVAN TRANSPORTER**



≥ 2003 - H1 - L1/L2

Installation on rail. For the Transporter version the rail is optional:  
contact the VW dealer to obtain the rail.

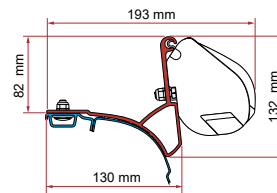

Quantity / Length      Item No.

Kit VW T5 / T6 Multivan/ Transporter      2 x 12cm      98655-747



**KIT VW T5 / T6 CALIFORNIA**



≥ 2003  
H1 - L1

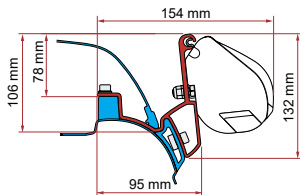

Quantity / Length      Item No.

Kit VW T5 / T6 California      2 x 12cm      98655-748



**KIT BRANDRUP VW T4**



≥ 1990 ≤ 2003  
H1 - L1/L2

Reimo Multirail

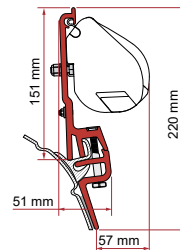

Quantity / Length      Item No.

Kit Brandrup VW T4      2 x 8cm      98655Z011



● **KIT VW T4 / VW T4 LIFT ROOF**



≥ 1990 ≤ 2003  
H1 - L1/L2

Also for models  
with lift roof

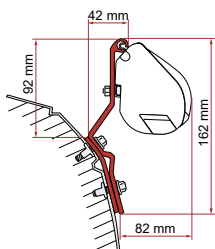

Quantity / Length      Item No.

Kit VW T4 Lift Roof      2 x 8cm      98655-111

● **KIT VW T3 / T3 LIFT ROOF**



≥ 1979 ≤ 1990  
H1

Also for models with  
lift roof

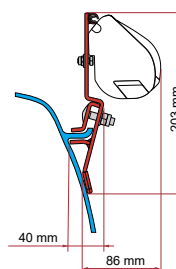

Quantity / Length      Item No.

Kit VW T3/T3 Lift Roof      2 x 8cm      98655Z115



● black finish brackets

\* for right hand drive

\*\* for left and right hand drive

● **KIT COMBI RAIL BRACKET**



Also for models with lift roof

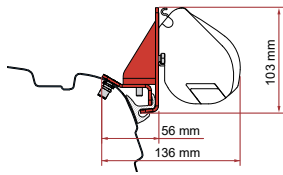

Quantity / Length      Item No.

Kit Combi Rail Bracket (Rail Brandrup - Vamoose)      2 x 8cm      \*\* 98655Z154

● **KIT MERCEDES VIANO / MARCO POLO / VITO / V CLASS**



H1 - L2  
Viano Vito II: ≥ 2003 ≤ 2013  
Viano Vito II Marco Polo: ≥ 2003 ≤ 2013 only with manual roof  
V Class Vito III - Long: ≥ 2014

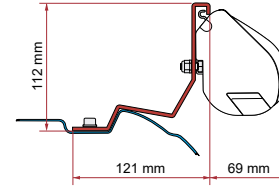

Quantity / Length      Item No.

Kit Mercedes Viano Marco Polo / Vito / V Class      2 x 13cm      98655-887

**KIT CLASS V MARCO POLO**



≥ 2014  
H1 - L2

Not suitable for Marco Polo with electric roof

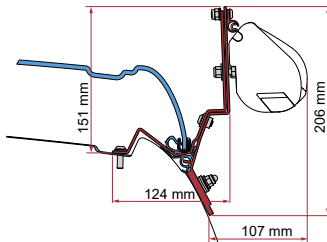

Quantity / Length      Item No.

Kit Class V Marco Polo      1 x 12cm - 1 x 13cm      98655Z022

● **KIT MERCEDES VITO / VITO MARCO POLO**



≥1996 ≤ 2003 / H1 - L1  
Marco Polo: only with manual roof

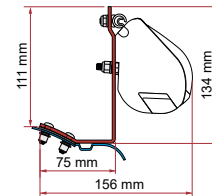

Quantity / Length      Item No.

Kit Mercedes Vito / Vito Marco Polo      2 x 8cm      98655-682

● **KIT MERCEDES VITO JULES VERNE**



≥ 2014  
H1 - L2

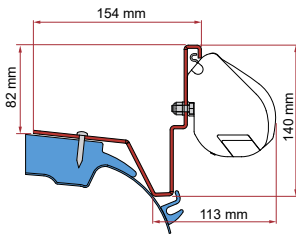

Quantity / Length      Item No.

Kit Mercedes Vito Jules Verne      2 x 12cm      98655Z034

**KIT RENAULT TRAFIC / OPEL VIVARO / FIAT TALENTO / NV300 / RAPIDO MIRANDE S**



≥ 2014 ≤ 2018 / H1 - L1/L2 - Opel/ Vauxhall Vivaro B  
≥ 2014 / H1 - L1/L2 - Renault Trafic/ Nissan Nv300/ Fiat Talento  
≥ 2015 / H1 - L1 - Renault Trafic Dreamer Mirande S/ Campereve Mirande S

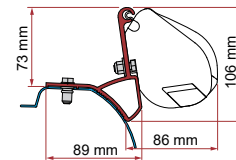

Quantity / Length      Item No.

Kit Renault Trafic / Opel Vivaro / Fiat Talento / NV300 / Rapido Mirande S      2 x 12cm      98655Z020

● **KIT NISSAN NV200**



H1 - L1  
Nissan NV 200 ≥ 2009 / Nissan Evalia ≥ 2010 / Mitsubishi Delica V ≥ 2007

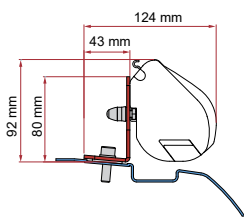

Quantity / Length      Item No.

Kit Nissan NV200      3 x 8cm      98655Z026

**KIT RENAULT TRAFIC / OPEL VIVARO / FIAT TALENTO / NISSAN PRIMASTAR**



≥ 2001 ≤ 2014  
H1 - L1/L2

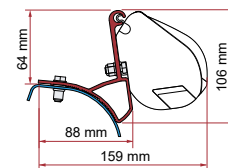

Quantity / Length      Item No.

Kit Renault Trafic / Opel Vivaro / Fiat Talento / Nissan Primastar      2 x 12cm      98655-893

● black finish brackets      \* for right hand drive      \*\* for left and right hand drive



● **KIT FORD CUSTOM GROUPE RAPIDO**



≥ 2024 H1 - L2  
Campêrêve Cap Land / Dreamer Select Cap Land / Westfalia Kelsey / Stylevan Belize

new  
2025

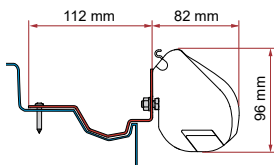

Quantity / Length      Item No.

Kit Ford Custom Groupe Rapido	2 x 12 cm	98655Z195
-------------------------------	-----------	-----------

● **KIT FORD CUSTOM LIFT ROOF**



≥ 2012 ≤ 2023 - H1 L1 / L2

Attention:  
opening/closing operations of the awning must be performed with the sliding door closed

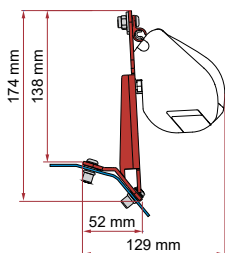

Quantity / Length      Item No.

Kit Ford Custom Lift Roof	2 x 12cm	98655Z169
Kit Ford Custom Lift Roof - RHD		* 98655Z170

● **KIT FORD CUSTOM CAP COAST / CAPLAND / CAPLIFE**



H1 - L1 Cap Coast ≥ 2018  
H1 - L2 Cap Land / Cap Life ≥ 2019

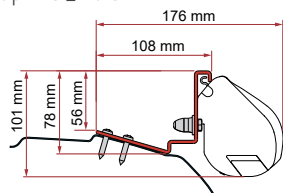

Quantity / Length      Item No.

Kit Ford Custom Cap Coast / Cap Land / Cap Life	2 x 12cm	98655Z027
---	----------	-----------

**RAIL**

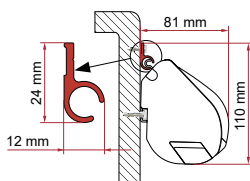

Quantity / Length      Item No.

Rail	1 x 300cm	02361-01A
	1 x 400cm	02361-01C

● **KIT FORD CUSTOM CAPLAND / CAPFUN**



≥ 2015 ≤ 2018  
H1 - L2

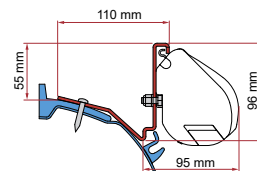

Quantity / Length      Item No.

Kit Ford Custom Cap Land / Cap Fun	2 x 12cm	98655Z035
------------------------------------	----------	-----------

● **KIT STANDARD**



Installation on Roof Rails

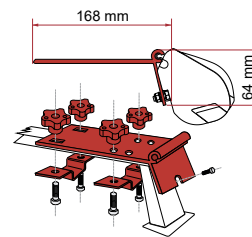

Quantity / Length      Item No.

Kit Standard	2 x 8cm	98655-142
--------------	---------	-----------

**KIT AUTO**



Installation on Roof Rails

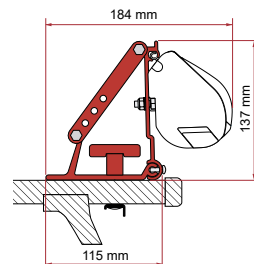

Quantity / Length      Item No.

Kit Auto	2 x 8cm	98655-310
----------	---------	-----------

**KIT ERIBA TOURING**

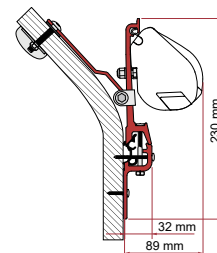

Quantity / Length      Item No.

Kit Eriba Touring	2 x 8cm	98655Z009
-------------------	---------	-----------

● black finish brackets

\* for right hand drive

\*\* for left and right hand drive

# Compass

## KIT VW T5 / T6 TRANSPORTER / MULTIVAN COMPASS

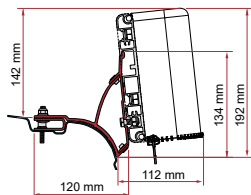

	Quantity / Length	Item No.
Kit VW T5/T6 Trasnporter / Multivan Compass	1 x 20cm - 1 x 25cm	98655Z018

## KIT RENAULT TRAFIC

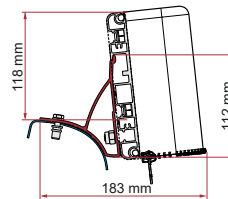

	Quantity / Length	Item No.
Kit Renault Trafic $\geq 2001 \leq 2015$	2 x 16cm	98655Z031
Kit Renault Trafic $\geq 2015$		98655Z032

## KIT ROOF RAIL

Rail max width 5,5cm  
Min. 2 Kits to install an awning

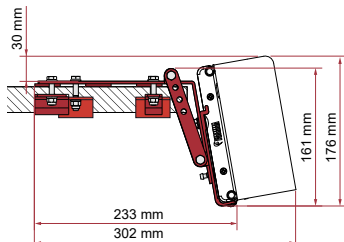

	Quantity / Length	Item No.
Kit Roof Rail	1 x 12cm	98655-770

## KIT AUTO

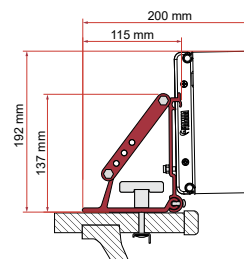

	Quantity / Length	Item No.
Kit Auto	2 x 8cm	98655-310

# CaravanStore

## KIT HOBBY CARAVANSTORE

Supplementary kit to fix the CaravanStore on Hobby caravans, 2009 production, edition 6.



	Item No.
Kit Hobby CaravanStore	98655-034

- black finish brackets
- \* for right hand drive
- \*\* for left and right hand drive



ENCLOSURES



Create your own  
private,  
safe and  
comfortable space



Your vehicle is transformed into a safe and cosy environment thanks to Fiamma walls and enclosures. Designed to offer you all the privacy and security you need, they are easy and quick to assemble. The wide range of models allows you to create an additional shady but bright space, protected from the weather. Choose the one that's right for you!



### FRONT AND SIDE PANELS

Fiamma Side and Blocker walls are quickly installed directly on the awning: they are designed to give you all the privacy you need, while maintaining easy access to the awning's shaded area.



### ENCLOSURES

Made up of a front and side panels joined together, they can be quickly fitted to the awning thanks to the Fast Clip system. Lightweight and elegant, they are equipped with large windows, mosquito nets and curtains.



### COMPLETE TENTS

Complete solutions consisting of awning, front and side panels, equipped with a robust zip fastener: together, they allow you to create a complete veranda in just a few minutes.



### ROOF TENT

Specific for minivans, SUVs and any vehicle equipped with roof bars: for an adventure completely immersed in nature!



### REAR DOOR ENCLOSURES

These practical enclosures are specifically designed for the rear of campervans and van conversions. In just a few steps, they increase the privacy and shaded area.



### SKIRTING FOR WIND PROTECTION

Our wind protectors, available for various types of vehicles, protect your relaxing moments from draughts.

# Choosing guide

Fiamma front and side panels are suitable for all types of vehicles and can be installed directly on the awning. How to choose the right one for you?

- Select the panel according to the model, length and extension of your awning
- Choose it according to the type of protection you want: from sun, rain and wind

## Blocker

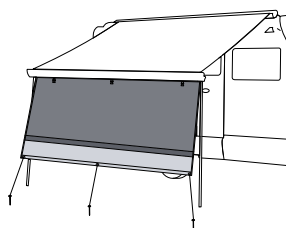

Protection from



Suitable for



F45s - F43van - F45L - F80s - F80L - F40van  
CaravanStore - F35pro

Panel length

from ± 253cm to ± 438cm

## Blocker Pro

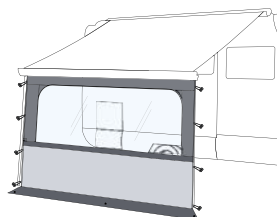

Protection from



Suitable for



F45s - F43van - F45L - F80s - F80L - F40van  
CaravanStore - F35pro

Panel length

from ± 100cm to ± 513cm

## Sun View XL

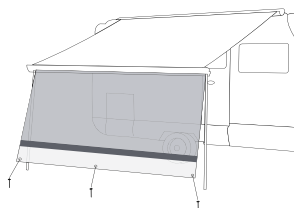

Protection from



Suitable for



F45s - F43van - F45L - F80s - F80L - F40van  
CaravanStore - F35pro

Panel length

from ± 100cm to ± 513cm

## Shade Sun View

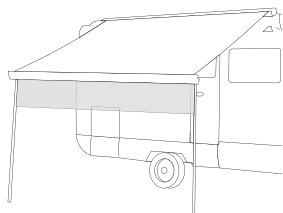

Protection from



Suitable for



F45s - F43van - F45L - F80s - F80L - F40van  
CaravanStore - F35pro

Panel length

± 600cm

## Side W Pro Shade

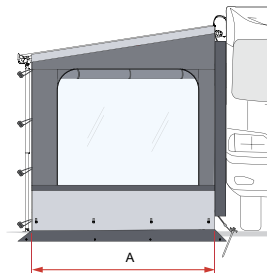

Protection from



Suitable for



F45s - F45L - F80s - CaravanStore

Length A

from 230cm to 240cm

## Side W Pro

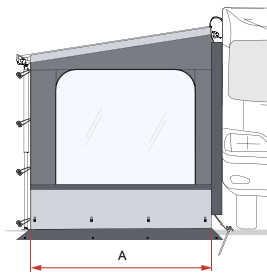

Protection from



Suitable for



F45s - F43van - F45L - F80s - F80L - F40van  
CaravanStore - F35pro

Length A

from 190cm to 250cm

## Side Block

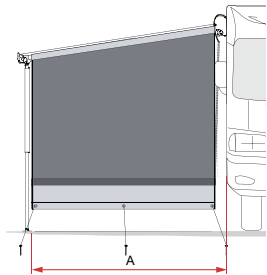

Protection from



Suitable for



F45s - F45L - F80s - CaravanStore

Length A

from 230cm to 240cm

## Side W Caravanstore

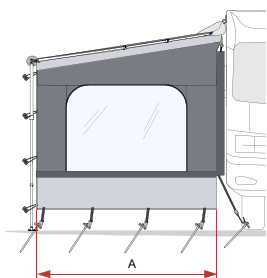

Protection from



Suitable for



CaravanStore - F35pro

Length A

from 210cm to 240cm

## Sun View Side

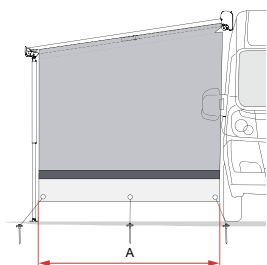

Protection from



Suitable for



F45s - F43van - F45L - F80s - F80L - F40van  
CaravanStore - F35pro

Length A

from 190cm to 20cm





# Blocker

SUITABLE FOR MOTORHOMES, CARAVANS, VAN CONVERSIONS, CAMPERVANS AND 4x4



The Fiamma front walls allow easy access to the awning's shaded area, giving you greater protection.

**FEATURES:**

- Quick installation
- They are also suitable for awnings of other brands
- Crystal full light window (Blocker Pro)

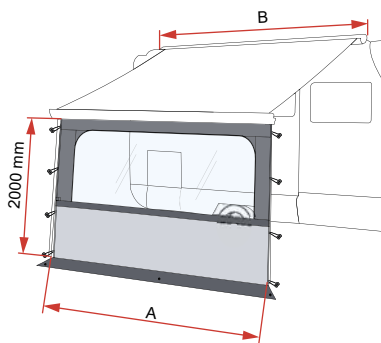

**BLOCKER PRO**   

Front panel with a large Crystal full light window, with extension to the ground. Made of rot-proof, washable and easy to assemble vinyl fabric with UV protection.

Complete with:

- elastics hooks and pegs for fastening

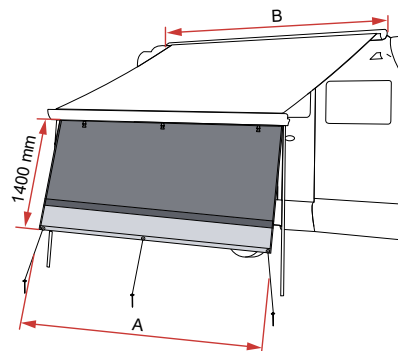

**BLOCKER**  

Convenient front panel that protects you from sun light and rain and gives you more privacy.

Complete with:

- ropes and pegs for fastening

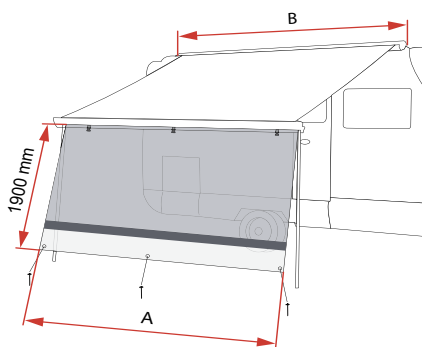

**SUN VIEW XL** 

Comfortable front panel. Made of translucent light filtering fabric, which partially blocks out light. It can be rolled up with convenient fixing clips.

Supplied with:

- ropes and pegs for fastening

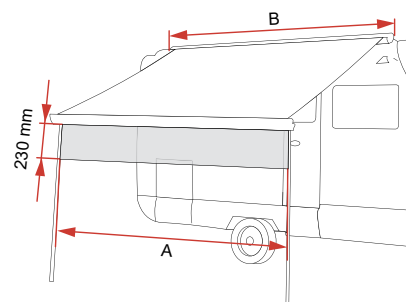

**SHADE SUN VIEW** 

The Shade Sun View valance with translucent light filtering material protects from sun and rain extending the shade surface.

Suitable for all awning models, single length 600cm easily adjustable to the length of the awning.



**CHOOSE THE MODEL THAT SUITS YOU**

	F45s	F43van	F45L	F80s	F80L	F40van	CStore	F35pro	Length A	Min. awning length B	Weight	Item No.
Blocker Pro	Blocker Pro 100 *	●		●	●		●	●	± 100cm	-	0,8kg	07971-12-
	Blocker Pro 250	●					●	●	± 235cm	250cm	2,7kg	07971-01-
	Blocker Pro 260Van	●	●					●	± 250cm	260cm	2,7kg	07971A01-
	Blocker Pro 280						●	●	± 255cm	270cm	3,0kg	07971-02-
	Blocker Pro 300	●	●		●		●	●	± 285cm	300cm	3,2kg	07971-03-
	Blocker Pro 325	●			●				± 310cm	325cm	3,4kg	07971-13-
	Blocker Pro 350	●			●		●		± 335cm	340cm	3,8kg	07971-04-
	Blocker Pro 375	●			●				± 360cm	370cm	4,1kg	07971-05-
	Blocker Pro 400	●			●		●		± 385cm	400cm	4,5kg	07971-06-
	Blocker Pro 425	●			●				± 410cm	425cm	4,7kg	07971-07-
	Blocker Pro 440						●		± 415cm	440cm	4,9kg	07971-08-
	Blocker Pro 450	●		●	●	●			± 435cm	450cm	5,0kg	07971-09-
	Blocker Pro 500			●		●	●		± 463cm	500cm	5,5kg	07971-10-
	Blocker Pro 550			●		●	●		± 513cm	550cm	6,0kg	07971-11-
Blocker	F45s	F43van	F45L	F80s	F80L	F40van	CStore	F35pro	Length A	Min. awning length B	Weight	Item No.
	Blocker 260	●	●		●		●	●	± 253cm	250cm	2,3kg	07972-04-
	Blocker 300	●	●		●		●	●	± 285cm	300cm	2,6kg	07972-01-
	Blocker 325	●			●				± 310cm	320cm	2,7kg	07972-06-
	Blocker 350	●			●		●		± 335cm	340cm	2,9kg	07972-02-
	Blocker 400	●		●	●	●	●		± 385cm	400cm	3,3kg	07972-03-
Blocker 450	●		●	●	●	●		± 438cm	450cm	4,0kg	07972-05-	
Sun View XL / Shade Sun View	F45s	F43van	F45L	F80s	F80L	F40van	CStore	F35pro	Length A	Min. awning length B	Weight	Item No.
	Sun View XL 100	●	●	●	●	●	●	●	± 100cm	-	0,5kg	08184-01-
	Sun View XL 260	●	●		●		●	●	± 250cm	250cm	1,9kg	08184-02-
	Sun View XL 300	●	●		●		●	●	± 285cm	300cm	2,1kg	08184-03-
	Sun View XL 325	●			●				± 310cm	325cm	2,2kg	08184-11-
	Sun View XL 350	●			●		●		± 335cm	340cm	2,3kg	08184-04-
	Sun View XL 375	●			●		●		± 360cm	370cm	2,4kg	08184-05-
	Sun View XL 400	●			●		●		± 385cm	400cm	2,5kg	08184-06-
	Sun View XL 425	●			●		●		± 410cm	425cm	2,6kg	08184-07-
	Sun View XL 450	●		●	●	●	●		± 435cm	450cm	2,7kg	08184-08-
	Sun View XL 500			●		●	●		± 463cm	500cm	2,9kg	08184-09-
	Sun View XL 550			●		●	●		± 513cm	550cm	3,1kg	08184-10-
Shade Sun View	●	●	●	●	●	●	●	●	± 600cm	190cm	0,5kg	07758-01-

● Suitable for  
 \* Blocker Pro 100 doesn't have Crystal window.  
 For 600cm long awnings, use one 500cm and one 100cm panel

**ACCESSORIES**

**MEGA BAG**

Large, strong bag for storing the front and side panels of the Blocker and Side range or any other accessory you want to protect. Available in two sizes (p. 106).











Sun View XL



Sun View XL 100





# Side

SUITABLE FOR MOTORHOMES, CARAVANS, VAN CONVERSIONS, CAMPERVANS AND 4x4



Our side panels, which can be installed directly on the awning, give you more privacy while protecting you from wind, rain and sun.

**FEATURES:**

- Quick installation, they are also suitable for awnings of other brands
- Crystal full light windows (Side W Pro / Pro Shade / CaravanStore)

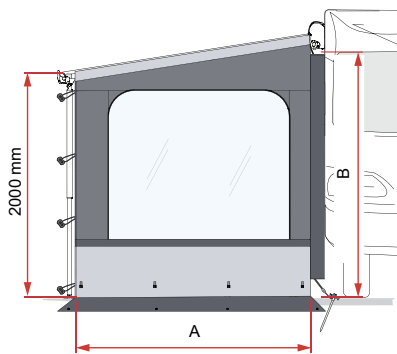

**SIDE W PRO**   

Side panel with large Crystal full light window and grey extension to the ground, made of rot-proof, UV-resistant and washable vinyl.

Complete with:

- aluminium rafter
- pegs

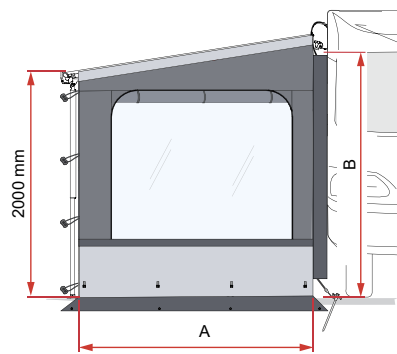

**SIDE W PRO SHADE**   

Side enclosure with large Crystal full light window, roller blind and grey extension to the ground, made of rot-proof, UV-resistant and washable vinyl.

Complete with:

- aluminium rafter
- pegs

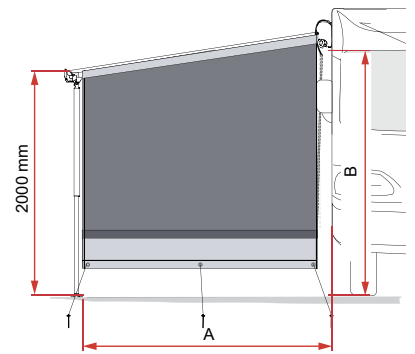

**SIDE BLOCK**  

Vinyl side panel can be combined with Blocker front wall. Washable, rot-proof and UV-resistant.

Complete with:

- aluminium rafter
- tension ropes and pegs

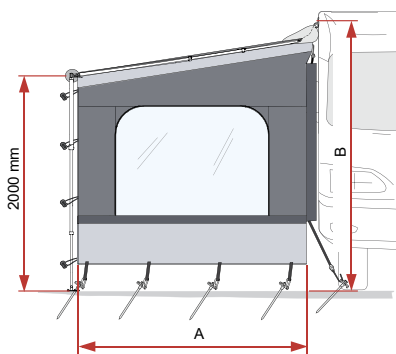

**SIDE W CARAVANSTORE**  

Side panel with large Crystal full light window made of rot-proof, UV-resistant and washable vinyl.

Complete with:

- aluminium rafter
- pegs

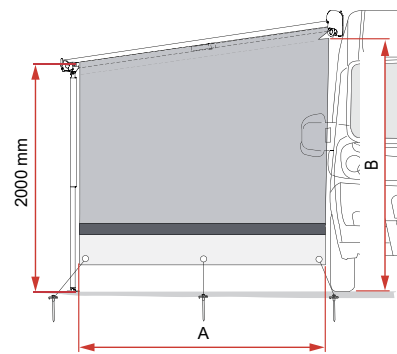

**SUN VIEW SIDE** 

Side panel made of translucent light filtering fabric, which partially blocks out light.

Complete with:

- aluminium rafter
- tension ropes and pegs

**ACCESSORIES**



**MEGA BAG**

Large, strong bag for storing the front and side panels of the Blocker and Side range or any other accessory you want to protect. Available in two sizes (p. 106).



**CHOOSE THE MODEL THAT SUITS YOU**

	F45s / F45L	F43van	F80s / F80L	F40van	CStore / XL	F35pro	Length A	Height from ground B	Weight	Item No.	
Side W Pro	Side W Pro Van F45	●					190 cm	180-200 cm	3,4 kg	07973A01-	
	Side W Pro Van F43 270 ext. 225 <b>[New]</b>		●				210 cm	180-210 cm	4,5 kg	08980-01-	
	Side W Pro Van F43 300 ext. 250 <b>[New]</b>		●				230 cm	180-210 cm	4,9 kg	08980A01-	
	Side W Pro F45 / F80s	●		●			230 cm	225-280 cm	4,2 kg	07973-01-	
	Side W Pro XXL F45 / F80s	●		●			230 cm	280-330 cm	4,5 kg	07973B01-	
	Side W Pro F80L XL			●			250 cm	245-280 cm	4,8 kg	07974A01-	
	Side W Pro F80L XXL			●			245 cm	281-310 cm	4,9 kg	07974B01-	
	Side W Pro Ducato F80			●**			230 cm	245-280 cm	4,2 kg	07974-01-	
	Side W Pro F40				●		210 cm	180-210 cm	3,0 kg	07979-01-	
	Side W Pro CaravanStore / F35					●	●	210 cm	240-260 cm	4,5 kg	07977-01-
	Side W Pro CaravanStore XL					●		240 cm	240-260 cm	4,8 kg	07977B01-
	Side W Pro F35 Van						●	210 cm	180-220 cm	4,2 kg	07977A01-
Side W Pro Shade	Side W Pro Shade F45 / F80s Right	●		●			230 cm	225-280 cm	5,3 kg	07975-01- /	
	Side W Pro Shade F45 / F80s Left	●		●			230 cm	225-280 cm	5,3 kg	07976-01-	
	Side W Pro Shade CStore XL Right <b>[New]</b>				●		240 cm	240-260 cm	6,5 kg	09000-01-	
	Side W Pro Shade CStore XL Left <b>[New]</b>				●		240 cm	240-260 cm	6,5 kg	08999-01-	
Side Block	Side Block F45 / F80	●		●**			230 cm	220 - 260 cm	3,3 kg	08835-01-	
	Side Block CaravanStore				●		240 cm	240 - 260 cm	3,3 kg	08836-01-	
Side W	Side W CaravanStore / F35				●	●	210 cm	240-260 cm	3,9 kg	07978-01-	
	Side W CaravanStore XL				●		240 cm	240-260 cm	4,2 kg	07978A01-	
Sun View Side	Sun View Side Van F45s <b>[New]</b>	●					190 cm	180-210 cm	2,3 kg	08989-01-	
	Sun View Side Van F40van / F43van ext. 225 <b>[New]</b>		●		●		210 cm	180-210 cm	2,4 kg	08990-01-	
	Sun View Side Van F43van ext. 250 <b>[New]</b>		●				230 cm	180-210 cm	2,7 kg	08990A01-	
	Sun View Side F45 / F80s	●		●			230 cm	220-260 cm	1,4 kg	08185-01-	
	Sun View Side F80L			●			250 cm	245-310 cm	1,7 kg	08185A01-	
	Sun View Side CaravanStore / F35					●	●	210 cm	180-260 cm	1,3 kg	08186-01-
	Sun View Side CaravanStore XL					●		240 cm	180-260 cm	1,6 kg	08186A01-
Kit Side	Kit Side F65s / F65L *								0,1 kg	98655-073	
	Kit Side Omnistor 5002 / 5003 *								0,1 kg	98655-311	
	Kit Side Tristor *								0,1 kg	98655-079	
	Kit Side Omnistor 4900 / 5200 - Tristor 2 *								0,1 kg	98655-927	

● Suitable for

\* The Kit Side allow installation of Side W Pro F45 / F80s, Side W Pro Shade and the Sun View Side F45 / F80s on F65 awnings and on Thule Omnistor 5002 / 5003 / 4900 / 5200 and Tristor/Tristor 2 awnings.

\*\* Only F80s





Sun View Side





Side Block - Blocker



Side W Pro Shade



# Choosing guide

Do you already own an awning? Our enclosures allow you to create a real open-air room in a few simple steps. How to choose the right one?

- Select the enclosure according to the model of your awning: manual or winch opening
- Choose the enclosure that best suits the season of the year in which you will be using it

## Privacy Room

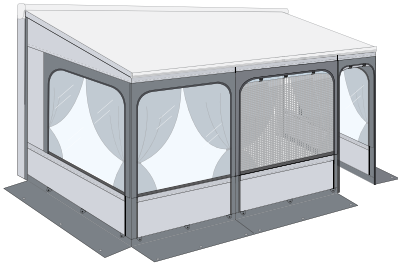

Suitable for



F45s - F45L - F80s - F80L

Recommended season



Installation speed



## Privacy Room Light / CS Light

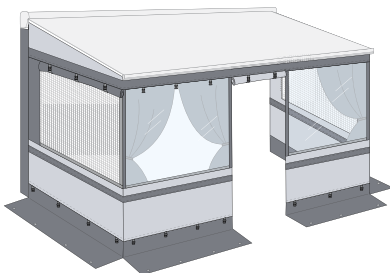

Suitable for



F45/F80s (P.R. Light)  
F35pro (P.R. CS Light Van)  
CStore XL (P.R. CS Light XL)

Recommended season



Installation speed



Suitable



Not suitable

Awning models (out of production)	Year	Privacy Room	Privacy Room Light	Privacy Room CS Light /XL
F1 / F1 L on base F45i/iL	2001 / 2006	•	•	
F45i / F45i L	2003 / 2007	•	•	
F65 Top	2000 / 2006	•	•	
F1 Ti	2007 / 2008	•	•	
F45 Ti / F45 Ti L	2008 / 2011	•	•	
F65s	2009 / 2018	•		
F65L / F65L 2017	2013 / 2019	•		
F70	2016 / 2020	•*	•**	

\* F70 with Kit Optional Item No. 98661-002  
(\*\*) only for 400cm





## Privacy Ultra Light

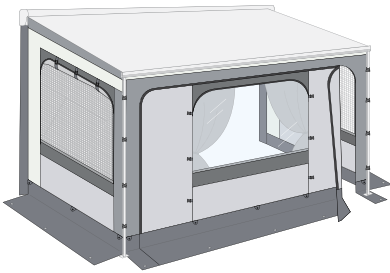

Suitable for



F45s - F45L - F80s

Recommended season



Installation speed



## Room Van Premium

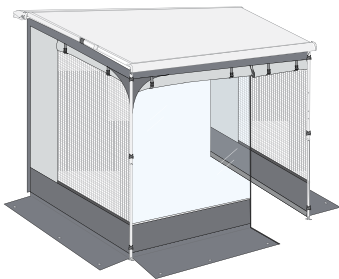

Suitable for



F43van - F40van

Recommended season



Installation speed



Suitable Not suitable

Awning models (out of production)	Year	Privacy Room Ultra Light	Room Van Premium
F1 / F1 L on base F45i/iL	2001 / 2006	•	
F45i / F45i L	2003 / 2007	•	
F65 Top	2000 / 2006	•	
F1 Ti	2007 / 2008	•	
F45 Ti / F45 Ti L	2008 / 2011	•	
F65s	2009 / 2018	•	
F65L / F65L 2017	2013 / 2019	•	
F70	> 2016	•	





# Privacy Room

SUITABLE FOR MOTORHOMES, CARAVANS, VAN CONVERSIONS AND CAMPERVANS



FOR FIAMMA WINCH AWNINGS F45s, F45L, F80s, F80L



Classic enclosure suitable for all seasons, the best solution for medium and long term stays.



**FEATURES:**

- Modularity: base modules (Van [S], Medium [M], Large [L], [XL] and [XXL]) and a broad range of additional panels
- Composed of front panels and two side panels
- All Crystal full light windows that can be rolled up, with mosquito net and curtains as standard
- The door can be positioned on the left side of the front panel and easily moved to the right side of the same
- Complete with anchor pegs and Bag (dim. 140x27x40 cm) to store Privacy Room and poles

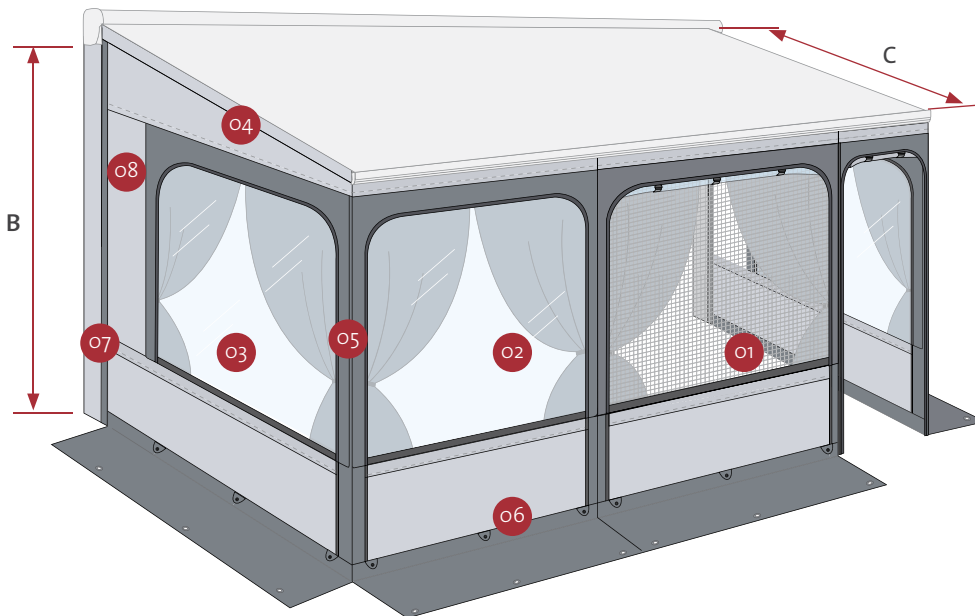

Basic module F45s / F45L (C = 200/250cm)	Height from ground (B)
[S]	180-220cm
[M]	225-250cm
[L]	251-280cm
Basic module F80s (C = 250cm)	Height from ground (B)
[S]	245cm
[M]	245-280cm
[L]	280cm
Basic module F80L (C = 275cm)	Height from ground (B)
[XL]	245-280cm
[XXL]	281-310cm

- |   |  |  |   |
|---|--|--|---|
| <p><b>01 Panels</b><br/>With roll-up Crystal full light window, fitted with mosquito net and curtains as standard</p> | <p><b>02 Additional front panels</b><br/>With fixed Crystal full light window and curtains as standard equipment</p> | <p><b>03 Windows</b><br/>Can be closed securely thanks to convenient zips and an extra layer of velcro</p> | <p><b>04 Fast Clip</b><br/>For quick and safe hooking to the awning fabric with internal lever hooks</p>                |
| <p><b>05 Zippers</b><br/>To hermetically join the panels together</p>   | <p><b>06 Vinyl fabric</b><br/>Waterproof and UV-resistant, rot-proof and easily washable</p>                         | <p><b>07 Protective sponge</b><br/>Additional vertical protection for the rear of the side panels</p>      | <p><b>08 Vertical Rafter</b><br/>Telescopic aluminium pole as standard (2 pcs), improves grip on the vehicle wall *</p> |

\* F80s version for Ducato complete Magnet Kit, without Vertical Rafter

**CREATE YOUR PRIVACY ROOM**

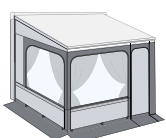

Basic module [S], [M], [L], [XL], [XXL] length 300cm

+



Additional panel

=

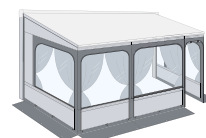

Privacy Room



**FOR FIAMMA AWNINGS F45s, F45L**

\* B = [S] h 180-220cm / [M] h 225-250cm / [L] h 251-280cm

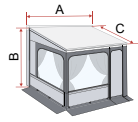

Basic module  
[S], [M], [L]



**T**



**G I O**



**P Q**



**U W**



**I W**

A	C	Basic module *	Weight	Front panels	Item No. Front panels	Weight
260	200cm	[S] 08366-01-	23,7kg	-	-	-
300 **				<b>G</b> (40cm)	08367-01-	0,4kg
300				-	-	-
325				<b>T</b> (25cm)	08364N01-	0,3kg
350	250cm	[M] 08366A01-	24,4kg	<b>I</b> (50cm)	08364B01-	0,6kg
375				<b>O</b> (75cm)	08364D01-	0,7kg
400				<b>P</b> (100cm)	08364E01-	0,9kg
425				<b>Q</b> (125cm)	08364F01-	1,2kg
450				<b>U</b> (150cm)	08364H01-	1,4kg
500				<b>W</b> (200cm)	08364M01-	1,9kg
550				<b>W + I</b> (200 + 50cm)	08364M01- + 08364B01-	1,9kg + 0,6kg

\*\* use with F45s 300 VW awning

**WHAT YOU CAN ADD TO YOUR PRIVACY ROOM**

Accessories - See page 104





**FOR FIAMMA AWNINGS F80s**

\* B = [S] h 245cm / [M] h 245-280cm / [L] h 280cm

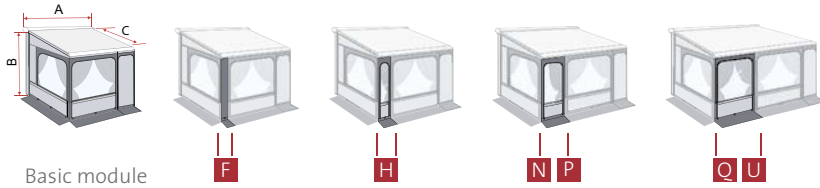

A	C	Basic module *	Weight	Front panels	Item No. Front panels	Weight
300				-	-	-
320		[S] 08760-01-		<b>F</b> (20cm)	08364-01-	0,3kg
340			23,2kg	<b>H</b> (40cm)	08364A01-	0,6kg
370	250cm	[M] 08368B01- **	23,2kg	<b>N</b> (70cm)	08364C01-	0,7kg
400			24kg	<b>P</b> (100cm)	08364E01-	0,9kg
425		[L] 08760A01- ***		<b>Q</b> (125cm)	08364F01-	1,2kg
450				<b>U</b> (150cm)	08364H01-	1,4kg

[S] and [L]: complete with magnet kit (2 sets of 6 magnets) which, inserted in the side panel pocket, permit complete adhesion to the Ducato vehicle.

\*\* This model is suitable for vehicles with straight wall, height from ground 245-280cm.

\*\*\* Designed for Mercedes Sprinter, VW Crafter, Fiat Ducato, Citroën Jumper and Peugeot Boxer - H3, Fast Clip Light aluminium poles delivered as standard.

**FOR FIAMMA AWNINGS F80L**

\* B = [XL] h 245-280cm / [XXL] h 281-310cm



A	C	Basic module *	Weight	Front panels	Item No. Front panels	Weight
450				<b>U</b> (150cm)	08364H01-	1,4kg
500		[XL] 08370-01-	24,2kg	<b>W</b> (200cm)	08364M01-	1,9kg
550	275cm		25,8kg	<b>W</b> (200cm) + <b>I</b> (50cm)	08364M01- 08364B01-	1,9kg + 0,7kg
600		[XXL] 08370A01-		<b>W</b> (200cm) + <b>P</b> (100cm)	08364M01- 08364E01-	1,9kg + 0,9kg

Item No.

Kit Privacy O

98655-901

Optional kit that allows the mounting of the Fiamma Privacy Room and Privacy Room Light on the awnings Thule Omnistor 4900-5002-5003-5200, Tristor 2.











# Privacy Room Light / CS Light

SUITABLE FOR MOTORHOMES, CARAVANS, VAN CONVERSIONS AND CAMPERVANS



FOR FIAMMA WINCH AND MANUAL AWNINGS F45, F45L, CS AND F35PRO



Aesthetic restyling of the Privacy Room Light and CS Light, featuring new colours and combinations, neutral Crystal, without decorations. Renewed polyester fabric for greater UV resistance; PVC basic module and Crystal windows made of higher-performance materials. Light and compact, suitable for summer or mid-season.



**FEATURES:**

- Modularity: base modules (Van [S], Medium [M], Large [L] and [E]) and a broad range of additional panels
- Front panel with roll-up Crystal full light window, fitted with mosquito net and curtains as standard, roll-up door
- Front additional panels with fixed Crystal full light window and standard curtains, or fixed blinds
- Side panels with roll-up blind and mosquito net
- Complete with anchor pegs and Bag Light (dim. 140x25x25 cm) to store Privacy Room and poles

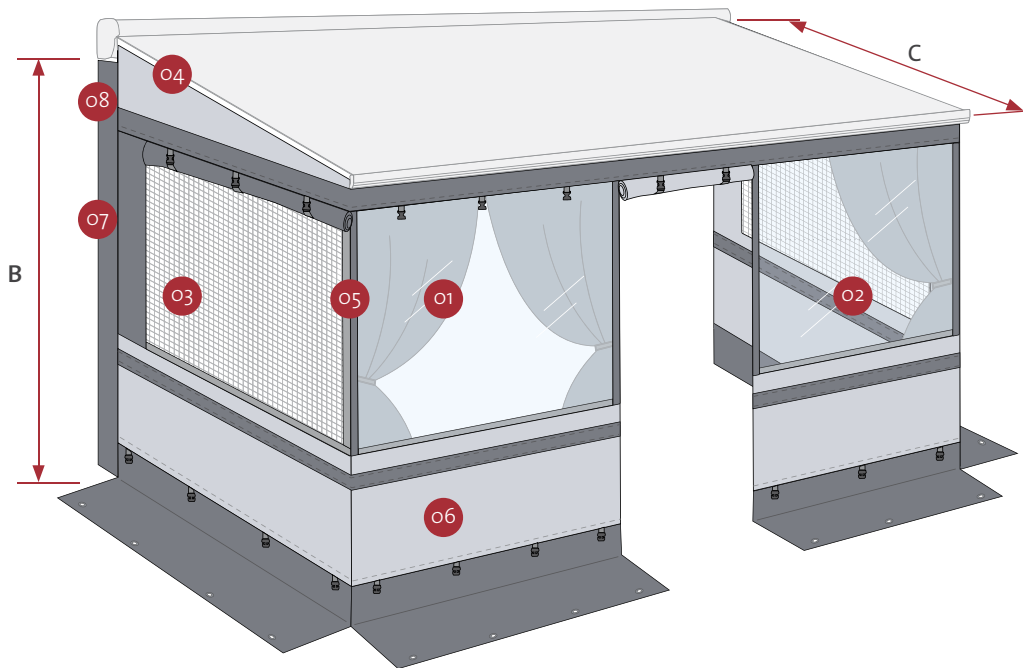

Basic module	Height from ground (B)
F45s / F45L	
[S]	180-220cm
[M]	225-250cm
[L]	251-280cm
Basic module F80s	Height from ground (B)
[S]	245cm
[M]	245-280cm
[L]	280cm
Basic module CS	Extension (C)
[E]	250cm

- 01 Front panel**  
With roll-up Crystal full light window, fitted with mosquito net and curtains as standard
- 02 Additional panels**  
With fixed Crystal full light window and standard curtains, or fixed blinds
- 03 Side panels**  
With roll-up blind and mosquito net
- 04 Fast Clip CS**  
For quick and safe hooking to the awning fabric with internal lever hooks
- 05 Zippers**  
To hermetically join the panels together
- 06 Polyester fabric**  
Lightweight, durable and washable
- 07 Kit Poles Light**  
Telescopic aluminium pole as optional (2 pcs), improves grip on the vehicle wall
- 08 Closing elastic**  
Is fixed to the awning and the ground to laterally close the Privacy

**CREATE YOUR PRIVACY ROOM LIGHT / CS LIGHT**

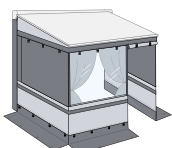

Basic module [S], [M], [L], [E]

+

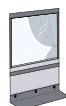

Additional panel

=

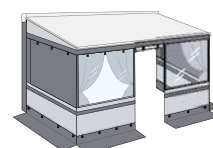

Privacy Room Light / CS Light



FOR FIAMMA AWNINGS F45s AND F45L

\* B = [S] h 180-220cm / [M] h 225-250cm / [L] h 251-280cm

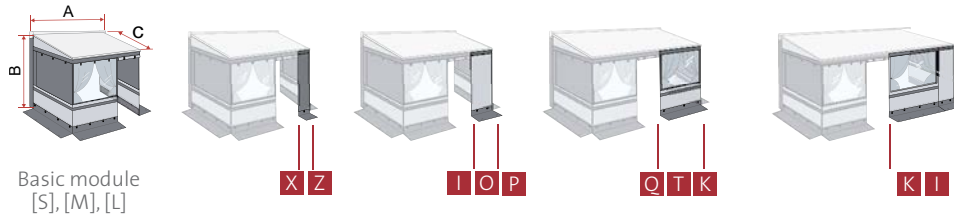

A	C	Basic module *	Weight	Front panels	Item No. Front panels	Weight
260	200cm	[S] 08765-01-	12,0kg	-	-	-
300 van				<b>X</b> (40cm)	08838-01	0,5kg
300				-	-	-
325	250cm	[M] 08765A01-	14,4kg	<b>Z</b> (25cm)	08766A01-	0,4kg
350				<b>I</b> (50cm)	08766B01-	0,6kg
375				<b>O</b> (75cm)	08766C01-	0,7kg
400				<b>P</b> (100cm)	08766D01-	0,8kg
425				<b>Q</b> (125cm)	08766E01-	0,9kg
450				<b>T</b> (150cm)	08766H01-	1,1kg
500				<b>K</b> (200cm)	08766L01-	1,4kg
550				<b>K</b> (200cm) + <b>I</b> (50cm)	08766L01- + 08766B01-	1,4kg + 0,6kg
		[L] 08765B01-	14,7kg			

WHAT YOU CAN ADD TO YOUR PRIVACY ROOM LIGHT / CS LIGHT

Accessories - See page 104



**FOR FIAMMA AWNINGS F80s**

\* B = [S] h 245cm / [M] h 245-280cm / [L] h 280cm

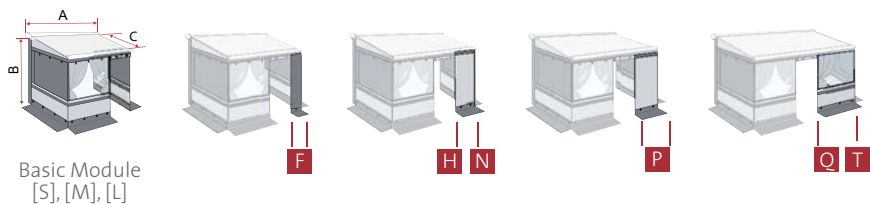

A	C	Basic module *	Weight	Front Panels	Item No.	Weight
300				-	-	-
320		Ducato H2 [S] 08837-01- **	14,6kg	<b>F</b> (20cm)	08766-01-	0,3kg
340				<b>H</b> (40cm)	08766M01-	0,5kg
370	250cm	h 245-280 cm [M] 08837B01- ***	14,8kg	<b>N</b> (70cm)	08766N01-	0,7kg
400		H3 [L] 08837A01- **	15,3kg	<b>P</b> (100 m)	08766D01-	0,8kg
425				<b>Q</b> (125cm)	08766E01-	0,9kg
450				<b>T</b> (150cm)	08766H01-	1,1kg

\*\* Complete with magnet kit (2 sets of 6 magnets) which, inserted in the side panel pocket, permit complete adhesion to the Ducato vehicle.

\*\*\* This model is suitable for vehicles with straight wall, height from ground 245-280cm.

**FOR FIAMMA AWNINGS CARAVANSTORE XL AND F35PRO**



A	B	C	Basic module *	Item No. Basic module	Weight	Front panels	Item No. Front panels	Weight	Suitable for
250	180-220cm	225 cm	P. R. CS Light 250 Van	08764A01-	8,7kg	-	-	-	F35pro 250
270			P. R. CS Light 270 Van	08764A02-	9,1kg	-	-	-	F35pro 270
280	240-260cm	250 cm	P. R. CS Light XL 280	08764B01-	12,1kg	-	-	-	CStore XL 280
310			-	-	-	-	-	-	CStore XL 310
360						<b>I</b> (50cm)	08766B01-	0,6kg	CStore XL 360
410						<b>P</b> (100cm)	08766D01-	0,8kg	CStore XL 410
440	240-260cm	250 cm	[E]	08764B02-	12,3kg	<b>R</b> (130cm)	08766F01-	1,0kg	CStore XL 440
500			<b>V</b> (190cm)	08766G01-	1,2kg	CStore XL 500			
550						<b>F + V + F</b> (20+190+20cm)	08766-01- + 08766G01-+ 08766-01-	0,3kg + 1,2kg + 0,3kg	CStore XL 550

**WHAT YOU CAN ADD TO YOUR PRIVACY ROOM LIGHT / CS LIGHT**

Accessories - See page 104





FIAMMASTORE



CARRY-BIKE

COMFORT





# Privacy Ultra Light

SUITABLE FOR MOTORHOMES, CARAVANS, VAN CONVERSIONS AND CAMPERVANS



FOR FIAMMA WINCH AWNINGS F45s, F45L, F80s



Enclosure consisting of roof, front and side panels. Quick to install, it is ideal for short stays or weekends.



## FEATURES:

- Double roof consisting of the awning cover and the Privacy roof, which allows a constant passage of air
- Single front panel complete with door, fixed Crystal full light window and curtains as standard. Possibility of making it completely removable
- Side panels with roll-up blind and mosquito net
- The shaded surface can be increased by completely lifting the side panels with Kit Poles (optional)
- Aluminium rafters and pegs for safe anchoring
- Complete with bag for storing privacy and poles: Bag Light for sizes 260-300-350 (dim. 140x25x25cm) and Bag for sizes 400-450 (dim. 140x27x40cm)

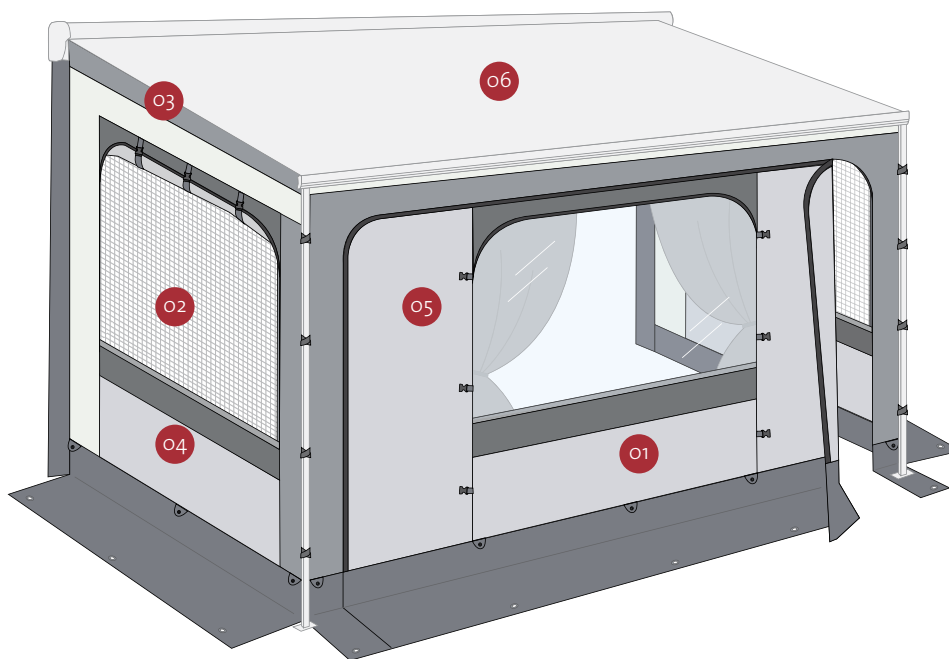

### 01 Front panel

Complete with door and fixed Crystal full light window. Possibility of making it completely removable

### 02 Side panels

With roll-up blind and mosquito net

### 03 One single piece

Consisting of roof, side and front panels

### 04 Opening sides

Possibility to open them increasing the shaded area with Kit Poles (optional)

### 05 Ripstop polyester fabric

Light and tear-resistant

### 06 Double roof

Composed of the awning fabric and the Privacy roof which create an air chamber with constant ventilation thus lowering the temperature inside the Privacy

## + WHAT YOU CAN ADD TO YOUR PRIVACY ULTRA LIGHT

Accessories - See page 104

FOR FIAMMA AWNINGS F45s, F45L, F80s

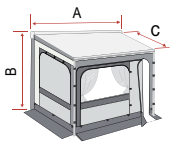

Privacy Ultra Light Van 260  
Privacy Ultra Light 300



Privacy Ultra Light 350

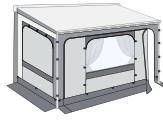

Privacy Ultra Light 400

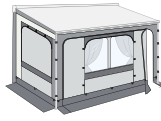

Privacy Ultra Light 450

	A	B	C	Weight	Item No.
Privacy Ultra Light Van 260	260cm	180-220cm	200cm	12,3kg	07350A01-
Privacy Ultra Light 300	300cm	230-280cm	250cm	14,2kg	07350-01-
	320cm				
Privacy Ultra Light 350	350cm	230-280cm	250cm	15,4kg	07350-02-
	370cm				
Privacy Ultra Light 400	400cm			16,6kg	07350-03-
Privacy Ultra Light 450	450cm			17,8kg	07350-04-





# Room Van Premium

SUITABLE FOR CAMPERVANS



FOR FIAMMA AWNINGS F40VAN AND F43VAN



Specific enclosure for F40van and F43van.

Without poles, it is quick to install and ideal for those who like to move on quickly.



## FEATURES:

- Light and without poles
- Consisting of roof, side and front panels, roll-up door, Crystal full light front panel and roll-up blind, side panels with mosquito nets and roll-up blinds
- Complete with Mega Bag

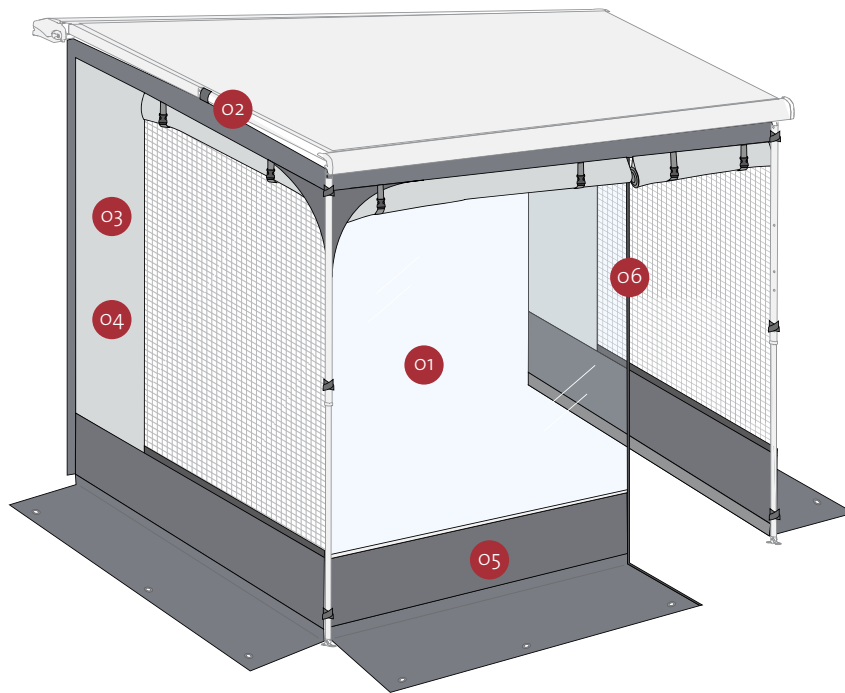

- |   |  |  |
|---|--|--|
| <p><b>01 Room Van Premium</b><br/>Roll-up door, Crystal full light front panel and roll-up blind, side panels with mosquito nets and roll-up blinds</p> | <p><b>02 Fixing</b><br/>No poles, direct fixing to the case box and the lead bar of the awning</p>                   | <p><b>03 One single piece</b><br/>Made in one piece consisting of roof, sides and fronts</p> |
| <p><b>04 Ripstop polyester fabric</b><br/>Light and tear-resistant</p>  | <p><b>05 Opening front panel</b><br/>Completely openable by increasing the shaded area (with optional Poles Kit)</p> | <p><b>06 Compact</b><br/>Takes up little storage space in the Mega Bag provided</p>          |

## + WHAT YOU CAN ADD TO YOUR ROOM VAN PREMIUM

Accessories - See page 104



☰ FOR THE AWNING FIAMMA F40VAN AND F43VAN

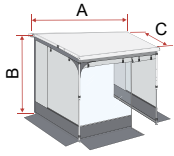

Room Van Premium

	F40van	F43van	A	B	C	Weight	Item No.
Room Van Premium 270 F40van / F43van	●	●	270cm	180-210cm	225cm	5,4kg	08870-01-
Room Van Premium 300 F43van		●	300cm	180-210cm	250cm	6,1kg	08210-02-

● Suitable for





# CaravanStore ZIP XL

SUITABLE FOR CARAVANS



COMPLETE TENT - MANUAL



Manual awning CaravanStore with zips, front and side panels with zips which, when joined together, create a complete veranda in a matter of minutes.



**FEATURES:**

- Awning CaravanStore with zips
- Privacy enclosure: front and side panels
- Zipper hinge system
- Crystal full light windows that can be rolled up, with mosquito net and curtains as standard
- Rapid Set and CS installation kit, elastic ropes with quick hooks as standard, complete with Bag (dim. 140x27x40 cm) to store Privacy Room and poles

Basic module CS XL	A
[D]	280cm
[E]	310cm

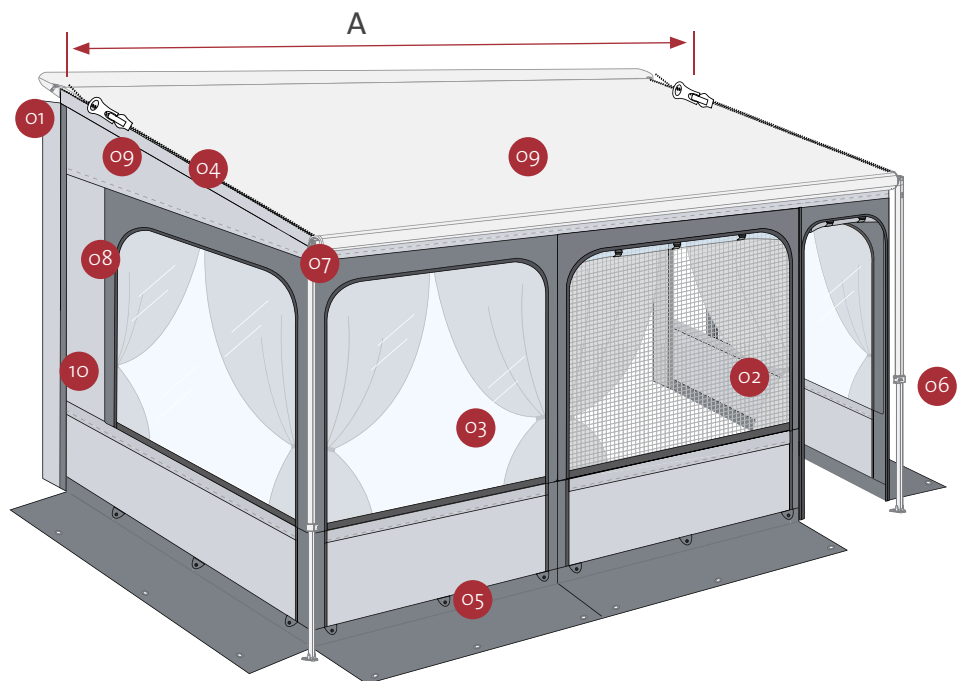

**01 Awning**  
CaravanStore with zips with grey bag

**02 Panels**  
With roll-up Crystal full light window, fitted with mosquito net and curtains as standard

**03 Windows**  
Can be closed securely thanks to convenient zips and an extra layer of velcro

**04 Zippers**  
Combine Privacy with the awning fabric

**05 Vinyl fabric**  
Waterproof, UV-resistant, rot-proof and washable

**06 Door**  
Can be positioned on either the right or left side of the front

**07 Flexyblock**  
System that reinforces the tension of the rafter thanks to the extension 250cm

**08 Support poles**  
CaravanStore Support Leg (from length 360) and Rafter CaravanStore (for length 440) for fabric tensioning

**09 Rapid Set CS**  
Composed of aluminium poles for the installation of the Privacy system

**10 Protective sponge**  
Additional vertical protection for the rear of the side panels

**CREATE YOUR CARAVANSTORE ZIP XL**

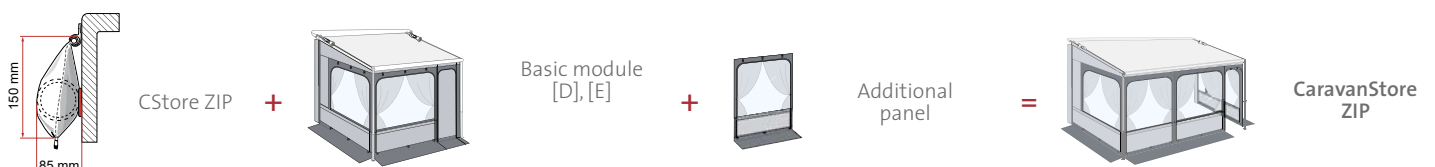



MODELS AND DIMENSIONS

\* A = [D] 280cm / [E] 310cm

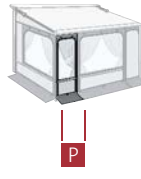
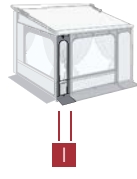
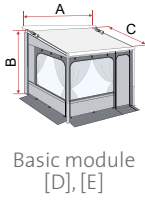
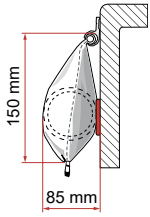

Awning	A	B	C	Item No. Awning	Weight	Basic module *	Weight	Front panels	Item No. Front panels	Weight
	280	240 - 260cm	250cm	06771C02(X)	10,6kg	[D] 08363-01-	21kg	-	-	-
	310			06771D02(X)	11,7kg	-	-	-		
	360			06771E02(X)	12,8kg	I (50cm)	08364B01-	0,6kg		
CS XL	410	240 - 260cm	250cm	06771F02(X)	14,0kg	+ [E] 08363-02-	21,3kg	P (100cm)	08364E01-	0,9kg
	440			06771G02(X)	15,1kg			R (130cm)	08364G01-	1,3kg
	500			06771H02(X)	16,3kg			V (190cm)	08364L01-	1,8kg
	550			06771L02(X)	17,5kg			F + V + F (20 + 190 + 20)	08364-01- + 08364L01- + 08364-01-	0,3kg

Specify the fabric colour you want when ordering by replacing (X) with: R=Royal Grey, Q=Royal Blue

WHAT YOU CAN ADD TO YOUR CARAVANSTORE ZIP

Accessories - See page 104







# Moonlight Tent

SUITABLE FOR CAMPERVANS, 4x4 AND CARS



FOR VEHICLES EQUIPPED WITH ROOF BARS



Roof tent ideal for trips in the great outdoors, designed for minivans, SUVs and any vehicle equipped with roof rails. New grey and olive-green colour scheme.



## FEATURES:

- Compatible with roof bars approved for >75kg and width >78cm
- Compatible with wall awnings
- 140 version homologated for 2 people, 180 version for 3 people
- Mosquito nets and blackout blinds can be opened on all 4 sides, complete rain cover with windows
- YKK closing hinges
- Equipped with 2.30 m aluminium ladder (max. load 150 kg) and waterproof cover bag
- Interior LED strip with adjustable light intensity, USB cable included

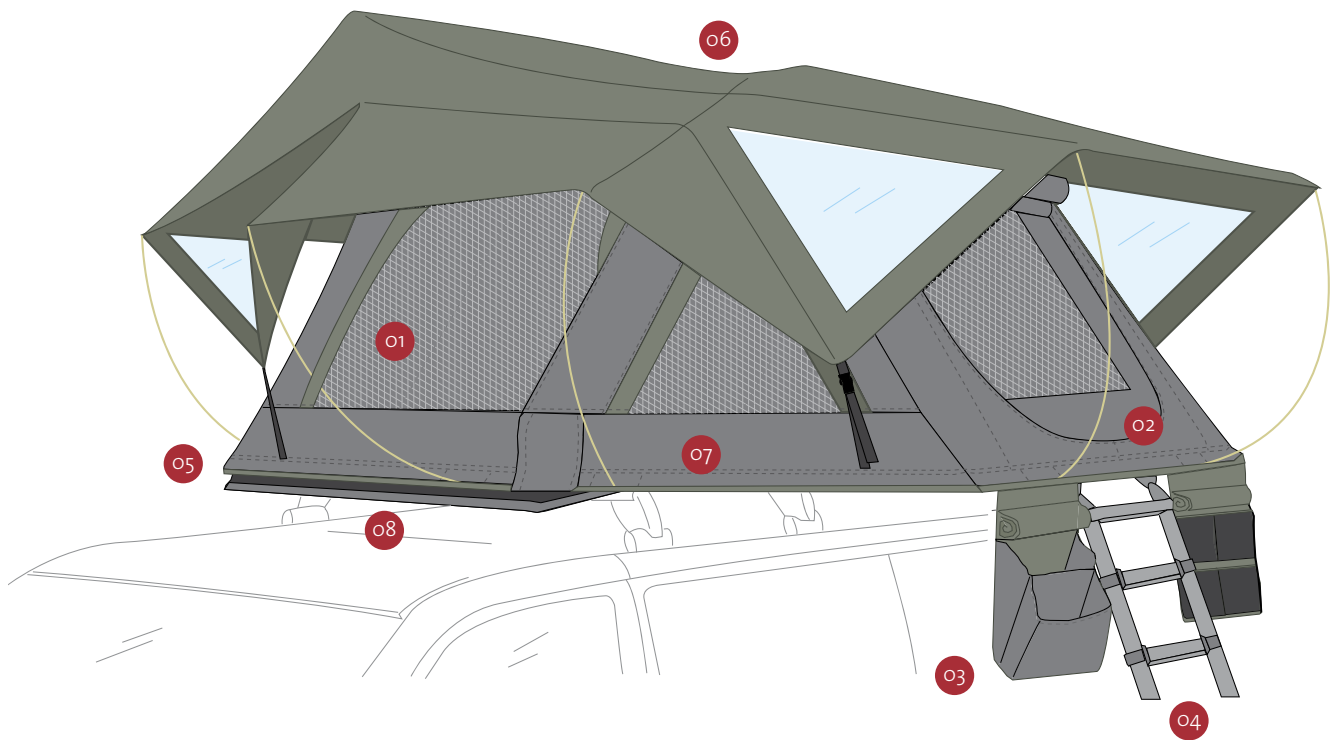

### 01 Windows

On all 4 sides, fitted with exterior opening mosquito net and interior opening blind

### 02 Inside front pocket

For storage of roof mounting rods

### 03 Bag

For better storage of your accessories and shoes

### 04 Telescopic ladder

Aluminium, height 2.3 m

### 05 Fabric

Tent: 200g/m<sup>2</sup>, Poly-cotton Canvas - UV 50+  
UP 2000mm  
Cover: Oxford 210D - UV 50+  
UP 3000mm  
Cover bag: Oxford 700D

### 06 Internal hook

For securing lights and other objects

### 07 Mattress with removable cover

5 cm thick consisting of 2 types of foam with different densities

### 08 Floor base

In aluminium honeycomb panels

**MODELS AND DIMENSIONS**

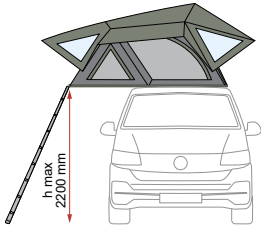

	Dimensions when open	Dimensions when closed	Internal dimensions	Weight *	Load capacity	No. of persons	Item No.
Moonlight Tent 140 <b>[Restyling]</b>	140 x 240 x 120cm	148 x 130 x 27cm	139 x 238 x 120cm	54kg	500kg	2 max	08972-01-
Moonlight Tent 180 <b>[Restyling]</b>	180 x 240 x 120cm	184 x 130 x 27cm	179 x 238 x 120cm	62kg	500kg	3 max	08973-01-

\* ladder included

**+ OPTIONAL - PRIVACY MOONLIGHT TENT**

Multi-purpose changing room for more privacy. New colour scheme to match the restyling of the roof awning, refinement and simplification to make it quick and easy to use. Suitable for minivans and SUVs.

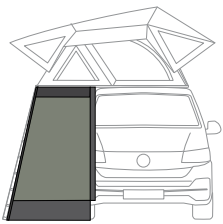

	Height from ground	Weight	Item No.
Privacy Moonlight Tent 140 <b>[Restyling]</b>	H=180-220cm	4,7kg	08996-01-
Privacy Moonlight Tent 180 <b>[Restyling]</b>		5,0kg	08997-01-

**+ OPTIONAL - ANTI-THEFT NUTS MOONLIGHT**

**new 2025** Anti-Theft Nuts Moonlight for Moonlight Tent for added product security. These special nuts attach to the installation brackets on the roof bars and are removable only with the included wrench.



	Weight	Item No.
Anti-Theft Nuts Moonlight <b>[New]</b>	0,1kg	08986-01-

**+ OPTIONAL - ANTI-CONDENSATION MAT**

**new 2025** Anti-condensation mattress mat. Placed between the aluminium base and the mattress, it prevents the transmission of any moisture, ensuring greater ventilation and improved comfort.



	Weight	Item No.
Anti-condensation Mat for Moonlight Tent 140 <b>[New]</b>	1,8kg	08974-01-
Anti-condensation Mat for Moonlight Tent 180 <b>[New]</b>	2,3kg	08974A01-









FIAMMASTORE



CARRY-BIKE



COMFORT





# Rear Door Cover

SUITABLE FOR VAN CONVERSIONS AND CAMPERVANS



Our practical tailgate enclosures for minivans and vans are designed to increase your privacy.

**FEATURES:**

- Quick installation
- To make the most of the space

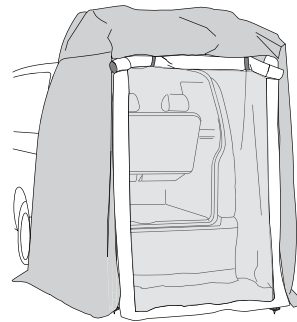
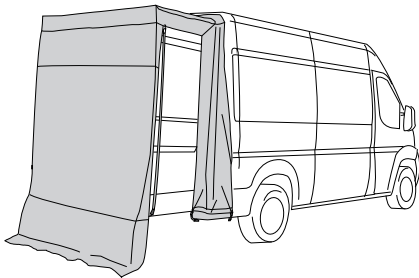

## REAR DOOR COVER DUCATO

Enclosure with side bands and a front folding closure. Suitable for Fiat Ducato, Citroën Jumper and Peugeot Boxer H2 after 2006 and Mercedes Sprinter H2 from 2006 to 2008. Complete with awning rafter, pegs and tensioning elastics.

## REAR DOOR COVER VW T5 / T6

Can be quickly installed on standard tailgates also with mounted bike rack (without bikes). It is an enclosure with a roll-up or extendable door and mosquito net. Complete with floor poles, pegs, tension elastics and Mega Bag Light.

**CHOOSE THE MODEL THAT SUITS YOU**

	Weight	Item No.
Rear Door Cover Ducato	3,3kg	06357-01-
Rear Door Cover VW T5 / T6	9,8kg	06539-01-
Kit Poles	0,7kg	06537-01-

**ACCESSORIES**

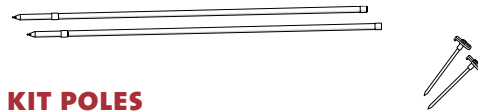

### KIT POLES

Set of two aluminium poles to extend the door as an additional awning.





# Skirting

SUITABLE FOR MOTORHOMES, CARAVANS, VAN CONVERSIONS AND CAMPERVANS



You can say goodbye to those annoying draughts coming from the underside of your vehicle.

## FEATURES:

- Can be shortened to awning size
- Different models for each type of vehicle

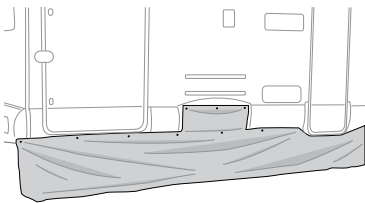

### SKIRTING MOTORHOME

For your motorhome or campervan, the wind protection comes complete with a kit with press studs.

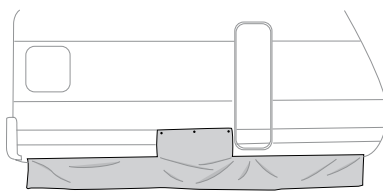

### SKIRTING CARAVAN

The wind protector that mounts on the caravan's standard rail.

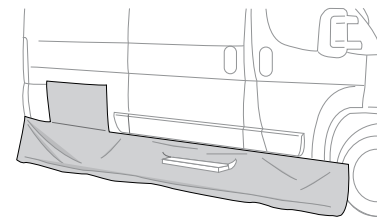

### SKIRTING DUCATO

Complete with wheel cover, elastic belts and magnets for attachment, it is suitable for wheelbases of lengths L2, L3 and L4.

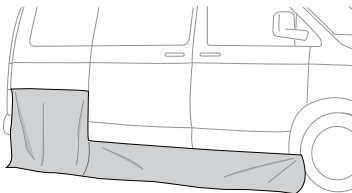

### SKIRTING VW T5 / T6

The perfect model for Volkswagen campervans, it comes complete with wheel cover, elastic belts and magnets for attachment.

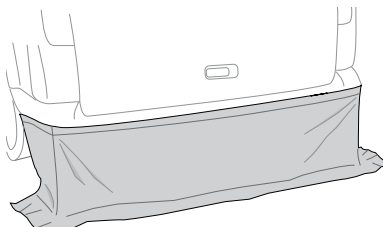

### REAR SKIRTING VW T5 / T6

Attach the wind protector to the back of your vehicle. Perfect in combination with Rear Door Cover VW T5 / T6.

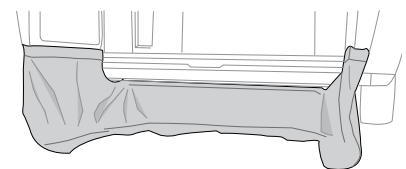

### REAR SKIRTING DUCATO

Attach the wind protector to the back of your vehicle. Perfect in combination with Rear Door Cover Ducato.

## CHOOSE THE MODEL THAT SUITS YOU

	Dimensions	Weight	Item No.
Skirting Motorhome	550x60hcm	1,7kg	98655-090
Skirting Caravan	450x60hcm	1,8kg	98655-084
Skirting Ducato	497x45h cm	1,4kg	98655-405
Skirting VW T5 / T6	250x42h cm	0,7kg	98655-387

	Weight	Item No.
Rear Skirting VW T5 / T6	1,1kg	06538-01-
Rear Skirting Ducato	1,7kg	06469-01-



# Accessories

Complete your enclosure with the right accessories to create a true open-air room.



## KIT MAGIC PRIVACY

In the event of wind, the best ally for giving greater stability to the walls of your Privacy.

Three versions available according to the length for the front panel, and one for the side panel.



## DOOR POLE

When you leave your Privacy door open, this telescopic vertical pole increases the stability of the front.



## CARAVANSTORE SUPPORT LEGS

Increase the strength of your CaravanStore with these reinforcement poles designed for application on the front tube. Delivered as standard with: CaravanStore XL from 440 and CaravanStore ZIP XL from 360.



## PACK ORGANIZER PRIVACY

Optimise the space inside your enclosure and keep everything within reach, thanks to these storage containers that attach directly to the panels.



## CURTAINS KIT DARK GREY

Dark Grey curtains for Privacy Room front and side panels and Blocker Pro front panels. Thicker material ensures complete black out granting complete privacy. Available kits: 2 and 6 pieces.



## RAIN CAPS

To prevent water from seeping into the Privacy in case of rain, don't miss our special pair of seals. To be applied on the awning side caps, suitable for F45s, F45L, Fiamma ZIP S and Fiamma ZIP L.





☰ CHOOSE THE MODEL THAT SUITS YOU

	Suitable for	Weight	Item No.
Kit Magic Privacy Front Short	For awnings 260 to 375	2,0kg	06856-01-
Kit Magic Privacy Front Medium	For awnings 400 to 450 For awnings 280 to 440 (CaravanStore)	2,7kg	06856-02-
Kit Magic Privacy Front Large	For awnings from 500 to 550 For awnings from 500 to 550 (CaravanStore) **	3,0kg	06856-03-
Kit Magic Privacy Side	For awnings with 250cm extension For awnings with 225cm and 250cm extension (CaravanStore) *	1,1kg	06856-04-

Other accessories for enclosure



\* with the addition of optional Door Pole  
\*\* with the addition of 2 optional Door Pole

Kit Magic Privacy not compatible with awning F80s/L

	Weight	Item No.		Weight	Item No.
Door Pole F45 - CaravanStore		05161-02-	Curtains Kit Dark Grey - 2 pz.	2,7kg	08761-01-
Door Pole F65	0,8kg	05161-08-	Curtains Kit Dark Grey - 6 pz.	3,0kg	08761A01-
Door Pole F80s / F80L		05161-09-	Rain Caps F45s	0,1kg	06893-01-
CaravanStore Support Leg	1,7kg	03732C01-	Rain Caps F45L	0,2kg	06893A01-
Pack Organizer Privacy	0,4kg	07366-01-			







# Accessories

Complete your enclosure with the right accessories to create a true open-air room.



## KIT POLES

Set of two aluminium poles to extend the door or the side panel as an additional awning, suitable for Privacy Ultra Light, Rear Door Cover Ducato and VW T5 / T6.



## KIT POLES LIGHT

Vertical support poles to increase the stability of the Privacy Room to the vehicles' wall. Optional for Privacy Room Light and Privacy Room CS Light.



## PRIVACY RAIL KIT

Kit of 4 rails, 100cm. each, for the installation of Pack Organizer S, L and Shoes inside the Privacy Room.



## MEGA BAG ELITE

Storage bag for panels and Privacy Room. Dimensions: 150x35x35cm. Equipped with wheels, internal net pockets with elastic border and reinforcement panel on the bottom and 2 on the sides.



## MEGA BAG SMART L

Storage bag for panels and Privacy Room. Dimensions: 195x25x25cm. Length increased, to hold and carry skis too with internal Velcro fasteners to secure skis and studded holes to allow small amounts of water to escape; with internal pockets.



## MEGA BAG / MEGA BAG LIGHT

New version, proposed alternative to the current bags supplied with Fiamma Privacy Rooms. Useful for storing panels and Privacy Rooms. **Mega Bag:** 140x27x40cm **Mega Bag Light:** 140x25x25cm



## PATIO MAT / PATIO MAT LIGHT

Comfortable completion mat for your Privacy. It is made of breathable, self-extinguishing and UV-resistant polypropylene. Also available in a Light version featuring a lighter fabric, without edging and equipped with a standard bag. Patio Bag is optionally available for the Patio Mat.





☰ CHOOSE THE MODEL THAT SUITS YOU

	Weight	Item No.
Kit Poles	0,7kg	06537-01-
Kit Poles Light	2,0kg	06020-01-
Privacy Rail Kit	2,0kg	07364-01-
Mega Bag Elite	1,2kg	08373-01-
Mega Bag Smart L	1,0kg	08374A01-
Mega Bag	1,1kg	08843-01-
Mega Bag Light	0,6kg	08844-01-
Patio Mat Light 290	2,2kg	08839-01-
Patio Mat Light 340	2,6kg	08840-01-
Patio Mat Light 390	2,9kg	08841-01-
Patio Mat Light 440	3,3kg	08842-01-

	Weight	Item No.
Patio-Mat 260	2,5kg	08756-01-
Patio-Mat 290	3,2kg	07681-01-
Patio-Mat 340	3,5kg	07682-01-
Patio-Mat 390	3,8kg	07683-01-
Patio-Mat 440	4,2kg	07684-01-
Patio-Mat 490	4,6kg	07701-01-
Patio-Mat 540	5,1kg	08757-01-
Patio-Bag	0,2kg	08206-01-



## **CARRY-BIKE**

The freedom to go wherever we want, without constraints, is the value that inspires all Fiamma products. We manufacture our bike carriers - 100% made in Italy - with high-quality and extremely durable materials, to ensure maximum safety in transport and the best performance over time, not forgetting protection and care for your bikes. Each bike carrier is designed to be mounted on a specific category of vehicle: from motorhome to caravan, from campervan to van conversion and even off-road vehicle. Take your bike, load it on your Fiamma Carry-Bike and leave for your next adventure!

# **Your bike, companion of travel.**





### MOTORHOMES

You can mount the Carry-Bike on the rear wall of the motor home without impairing the view to the rear: practical and safe.



### CARAVANS

Simply mount the Fiamma bike carrier on the A-frame or on the rear wall of the caravan to safely transport your bikes.



### CAMPERVANS

The campervan specific Carry-Bike models integrate perfectly with the design of your vehicle for everyday use in transporting your bicycles.



### VAN CONVERSIONS

You can mount the Fiamma bike carrier on the back of your van even if you have a double door!



### SUV

On the tailgate or spare tyre, your bike is always with you.



### GARAGE

Garage solutions are ideal if you want to transport your bikes safely in the garage of your motorhome.

### ACCESSORIES

From rails to bike covers, our specific accessories facilitate and complete the performance of your Carry-Bike.



# Selection guide

Every type of vehicle has its own Carry-Bike. How to choose the right one for you?

- Find the right model for your vehicle type
- Do you also transport E-bikes? Check that the bike carrier is suitable by looking for the corresponding symbol
- Select the model according to the maximum number of bicycles you wish to transport

## MOTORHOMES



– From page 114



Model		Bikes	Model	Bikes
PRO		2 / 4 max	PRO Hymer - Dethleffs	2 / 4 max
PRO C		2 E-Bike	Autotrail	2 / 2 max
UL		2 / 3 max	Pro C L80	2 / 4 max
CL			Trigano - CI - Roller Team	2 / 3 max
Lift 77		2 / 4 max 2 E-Bike		
Motor Lift 77		2 / 4 max 2 E-Bike		

## CARAVANS



– From page 122



Model		Bikes	Model	Bikes
Caravan Active		2 / 3 max 2 E-Bike	Caravan Hobby	2 / 3 max
Caravan XL A		2 / 2 max 2 E-Bike	Caravan Universal	2 / 2 max
Caravan XL A Pro 300		2 / 3 max 2 E-Bike	Simple Plus 200	
Caravan XL A Pro 200		2 / 2 max 2 E-Bike		

## CAMPERVANS



– From page 128



Model		Bikes	Model	Bikes
VW T6 Pro			Mercedes V Class Premium	 2 / 4 max 2 E-Bike
VW T6		2 / 4 max 2 E-Bike	Mercedes V Class Lift E-Bike	 2 / 2 max 2 E-Bike
VW T5 Pro			Ford Custom V710	 2 / 4 max 2 E-Bike
VW T5			Ford Transit Custom Nugget / Nugget Plus (Highroof)	 2 / 3 max 2 E-Bike
VW T5 / T6 D		2 / 2 max	Ford Custom	
VW Caddy		2 / 4 max 2 E-Bike	Ford Transit	2 / 3 max
VW T4		2 / 4 max	Opel Vivaro / Trafic / Talento	 2 / 4 max 2 E-Bike
VW T4 D		2 / 2 max	Opel Vivaro / Trafic / Talento D	 2 / 2 max 2 E-Bike
VW T3 - T25		2 / 3 max	PSA	 2 / 4 max 2 E-Bike
VW T2		2 / 2 max		
Mercedes Viano		2 / 3 max		
Mercedes Vito		2 / 4 max 2 E-Bike		

## VAN CONVERSIONS



– From page 140



Model	Bikes	Model	Bikes
Frame Ducato		200 DJ Ducato < 2006	2 / 2 max
Frame Sprinter		200 D	2 / 2 max
Frame VW Crafter			
DJ Ducato ≥ 06			
DJ Sprinter ≥ 06 / Crafter ≥ 06 ≤ 16	2 / 2 max		
DJ Crafter ≥ 17			
DJ Transit ≥ 14			

## SUV



– Page 147



Model	Bikes
Backpack	2 / 3 max
Backpack 4x4	2 / 2 max

## GARAGE



– From page 148



Model	Bikes
Garage Plus	2 / 4 max
Garage Standard	2 / 3 max
Garage Slide Pro Bike	2 / 2 max 2 E-Bike
Garage Pack	2 / 3 max
Garage Pack Plus	2 / 3 max
Carry-Moto Pro	-
Carry-Moto	-
Carry-Ramp	-

Why are our Carry-Bikes so safe?

Here are the main elements you will find in the different models.



**01 Telescopic rail support**  
Made of extruded round or oval section, can carry up to 4 bikes.



**02 Bull Shock Absorber**  
Device specially designed to absorb shock and vibrations during travel.

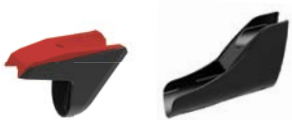

**03 Bike-Block Pro S**  
Scratch-proof bicycle locking device, characterised by ease of use on all frames.



**04 Easy Position**  
System that allows the installation of offset rails to better organise the loading of bicycles.



**05 Rails**  
With 3 models of wheel supports: robust, functional and safe.



Rail Premium



Rail Plus



Rail Quick Pro

**06 Quick Lock**  
Quick-Safe is the safety strap to safely mount and lock the wheels on the bike carrier rail. Easy release for immediate opening.



**07 Rack Holder**  
Rail support lock to ensure safe closing of the rail support base.









# Pro Series

SUITABLE FOR MOTORHOMES



FROM 2 TO 4 BIKES / 2 E-BIKE

The Pro series achieves standardisation of conventional and E-Bike models, thanks to the introduction of oval-section tubes and the Rail Plus rail, both of which are structurally more powerful.

## FEATURES:

- 6060 aluminium tubes with oval section
- Height-adjustable frame
- For transporting up to 4 standard bikes or 2 E-Bikes
- Rail support base block as standard to ensure greater stability near bumps and in the event of jolts

## MODELS



### PRO

Anodised aluminium frame with oval section tubes, height adjustable from 80 to 150cm.

## WHEELBASE

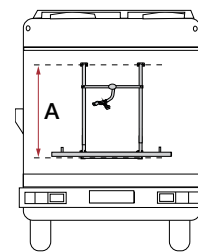

	Wheelbase A
Pro	80 - 150cm
Pro C	40 - 80cm



### PRO C

Compact structure with adjustable height from 40 to 80cm, ideal for vehicles with rear window.



**Telescopic rail support base**  
Aluminium, light weight and oval section, increased safety



**Rail support base block**  
To ensure greater stability near bumps and in the event of jolts



**Tubes**  
Aluminium 6060, oval section



CHOOSE THE MODEL THAT SUITS YOU

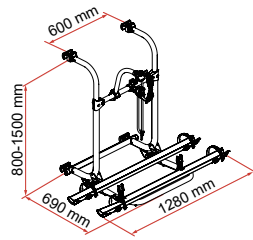

Pro

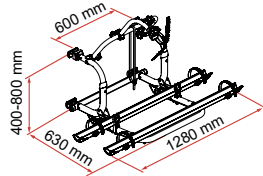

Pro C

	Pro	Pro C Pro C Deep Black
Item No.	02096-09- / 02096-09V **	02096-10- / 02096-10V ** 02096-10A / 02096V10A **
Weight	10,2kg	9,0kg
Max load	60,0kg	60,0kg
Bikes	2 / 4 max 2 E-Bike	2 / 4 max 2 E-Bike
Rail type	Rail Plus	Rail Plus
Bike-Block	Pro S 1 / Pro S 3	Pro S 1 / Pro S 3
Vertical wheelbase	80 - 150cm	40 - 80cm
Horizontal wheelbase (distance between brackets)	60cm	60cm
Dimensions *	128 x 69 x 80cm	128 x 63 x 40cm
Distance between rails	15cm	15cm
Easy position	●	●

\* with rail support base in standard open position and in models with minimum adjustable vertical wheelbase

\*\* N version (Item No. 02096-09V and 02096-10V) for vehicles with Fiamma original brackets pre-installed on it.

WHAT YOU CAN ADD TO YOUR CARRY-BIKE

Bike-Block

- See page 154

Rail

- See page 152

Accessories

- See page 155







# L Series

SUITABLE FOR MOTORHOMES



FROM 2 TO 3 BIKES

Ultra-reliable, affordable and lightweight it installs easily on most motorhome models and allows you to carry up to three standard bicycles on the back of the vehicle.

## FEATURES:

- Height-adjustable structure
- Aluminium 6060 rail support base light and resistant
- Lower fixing bar

## MODELS



### UL

Anodised aluminium structure, height adjustable from 80 to 150cm.



### CL

Compact aluminium structure, adjustable in height from 40 to 50cm. Ideal for vehicles with rear window.



#### Rail Quick Pro

For quick and secure locking of the wheel to the rail



#### Protective bumpers

To protect your bikes from scratches and impacts

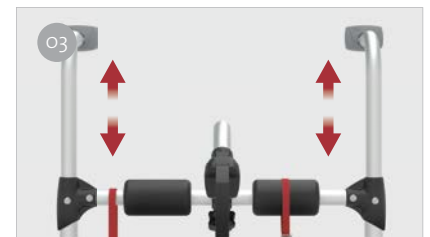

#### Upper structure

Height adjustable

CHOOSE THE MODEL THAT SUITS YOU

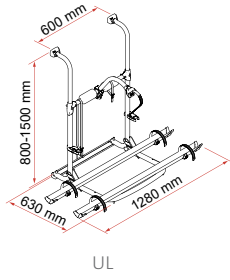

UL

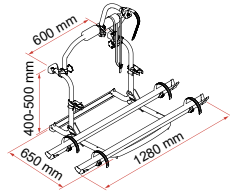

CL

	UL	CL
Item No.	02093B86A	02093B87A
Weight	5,6kg	5,6kg
Max load	50,0kg	50,0kg
Bikes	2 / 3 max	2 / 3 max
Rail type	Rail Quick Pro	Rail Quick Pro
Bike-Block	Pro S 3	Pro S 3
Vertical wheelbase	80 - 150cm	40 - 50cm
Horizontal wheelbase (distance between brackets)	60cm	60cm
Dimensions *	128 x 63 x 80cm	128 x 65 x 40cm
Distance between rails	15cm	15cm
Easy position	●	●

\* with rail support base in standard open position and in models with minimum adjustable vertical wheelbase

WHAT YOU CAN ADD TO YOUR CARRY-BIKE L SERIES

Bike-Block - See page 154

Rail - See page 152

Accessories - See page 155



# Lift 77 / Motor Lift 77

SUITABLE FOR MOTORHOMES



FROM 2 TO 4 BIKES / 2 E-BIKE



Available in 2 versions, motorised and manual, equipped with a lowerable support rail, which drops by up to 77cm for effortless loading and unloading of bicycles.

**Motor Lift 77:** motorised version, activation by push-button for easy ascent and descent

**Lift 77:** manual version, with crank handle with magnetic hooking, it can be shortened

## FEATURES:

- Dropping support rail that lowers by 77cm
- Height-adjustable structure
- Upper frame with double perforation to be able to move the horizontal support tube in the case of a rear camera placed on the vehicle
- 12V supply for Motor version
- Crank handle with magnetic coupling for manual version, that can be shortened

## MODELS

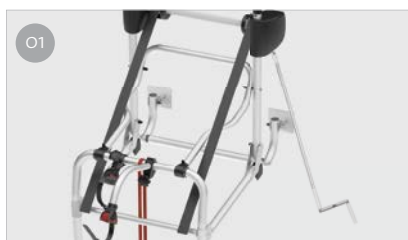

**Crank handle (Lift 77)**  
With magnetic hooking, it can be shortened

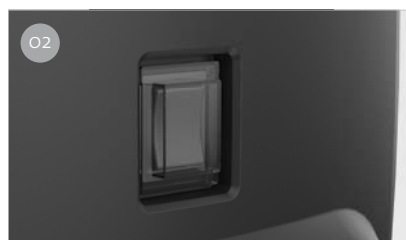

**Activation (Motor Lift 77)**  
By push-button for easy ascent and descent

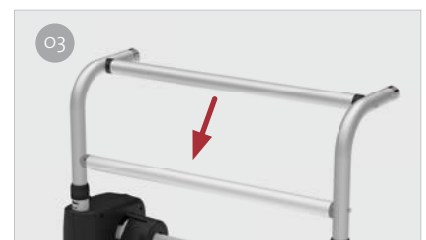

**Upper structure**  
With double perforations in order to be able to move the horizontal support tube



CHOOSE THE MODEL THAT SUITS YOU

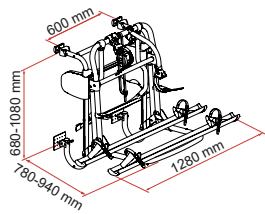

Motor Lift 77

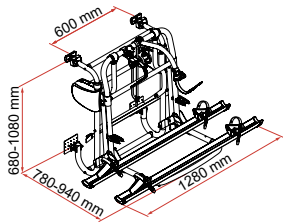

Lift 77

	Motor Lift 77	Lift 77
Item No.	02096-30-	02096-44-
Weight	17,4kg	15,6kg
Max load	60,0kg	60,0kg
Bikes	2 / 4 max 2 E-Bike	2 / 4 max 2 E-Bike
Rail type	Rail Premium	Rail Premium
Bike-Block	Pro S 1 / Pro S 3	Pro S 1 / Pro S 3
Vertical wheelbase	68 - 108cm	68 - 108cm
Horizontal wheelbase (distance between brackets)	60cm	60cm
Dimensions *	128 x 78 x 68cm	128 x 78 x 68cm
Distance between rails	15cm	15cm
Easy position	●	●

\* with rail support base in standard open position and in models with minimum adjustable vertical wheelbase

OPTIONAL - KIT ADAPTER CARRY-BIKE LIFT 77

Adapter kit for installing the bike carrier on vehicles already fitted with Kit Support Bar.

	Weight	Item No.
Kit Adapter Carry-Bike Lift 77	0,15kg	08724-01-



WHAT YOU CAN ADD TO YOUR CARRY-BIKE

Bike-Block - See page 154

Rail - See page 152

Accessories - See page 155





# Special Models

SUITABLE FOR MOTORHOMES



FROM 2 TO 4 BIKES

These bike carriers are designed to suit the characteristics of certain motorhome models, allowing them to be installed easily and safely.

## FEATURES:

- Based on Pro, Pro C (with round tubes) and CL
- Fast and safe installation
- Telescopic rail support base made of stainless steel AISI 304 and aluminium 6060 for models that carry up to 4 bikes
- Aluminium 6060 rail support base for models that carry 2/3 bikes



## MODELS



### PRO HYMER - DETHLEFFS

Specific for Dethleffs motorhomes: upper attachment kit available to fit the brackets fitted as standard on the vehicle.



### PRO AUTOTRAIL

Enlarged frame for installation on Autorail motorhomes fitted with rear wheel moulding, from 2011 onwards. Only suitable for Autorail vehicles with rounded rear wheel moulding and not the later hexagonal shaped mouldings.



### PRO C L80

For Laika motorhomes, horizontal wheelbase 80cm.



### TRIGANO - CI - ROLLER TEAM

Only suitable for CI and Roller Team with attachments pre-installed on the vehicle.

CHOOSE THE MODEL THAT SUITS YOU

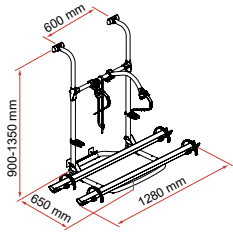

Pro Hymer - Dethleffs

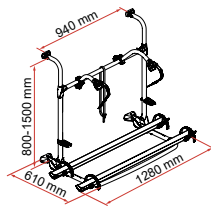

Pro Autotrail

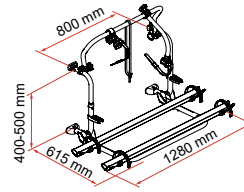

Pro C L80

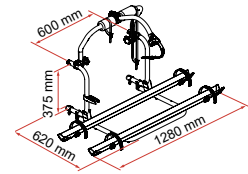

Trigano - Ci - Roller Team

	Pro Hymer - Dethleffs	Pro Autotrail	Pro C L80	Trigano - Ci - Roller Team
Item No.	02096-64A	02093A98A	02093B59A	02093A57A
Weight	8,2kg	12,0kg	7,9kg	5,2kg
Max load	60,0kg	40,0kg	60,0kg	50,0kg
Bikes	2 / 4 max	2 / 2 max	2 / 4 max	2 / 3 max
Rail type	Rail Quick Pro	Rail Quick Pro	Rail Quick Pro	Rail Quick Pro
Bike-Block	Pro S 1 / Pro S 3	Pro S 2 / Pro S 3	Pro S 1 / Pro S 3	Pro S 3
Vertical wheelbase	90 - 135cm	80 - 150cm	40 - 50cm	37,5cm
Horizontal wheelbase (distance between brackets)	60cm	94cm	80cm	60cm
Dimensions *	128 x 65 x 90cm	128 x 61 x 80cm	128 x 61,5 x 40cm	128 x 62 x 37,5cm
Distance between rails	15cm	30cm	15cm	15cm
Easy position	●	●	●	●

\* with rail support base in standard open position and in models with minimum adjustable vertical wheelbase

KIT DETHLEFFS

For Dethleffs motorhomes, the upper bracket kit is available, adaptable to the standard fitted brackets. To be used in combination with Pro Hymer-Dethleffs Carry-Bike.



	Weight	Item No.
Kit Dethleffs < 2010	0,4kg	98656-640
Kit Dethleffs > 2010	0,5kg	98656-725
Kit Dethleffs > 2016	0,5kg	98656M296

WHAT YOU CAN ADD TO YOUR CARRY-BIKE

Bike-Block - See page 154

Rail - See page 152

Accessories - See page 155

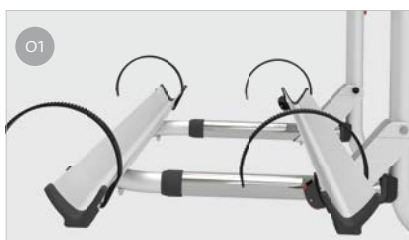

**Telescopic rail support base**  
For transporting up to 2,3,4 bikes depending on model



**Rail Quick Pro**  
For quick and secure locking of the wheel to the rail

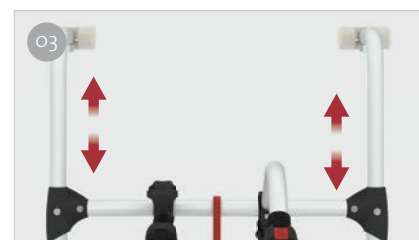

**Upper structure**  
Height adjustable



# Caravan: for the A-Frame

SUITABLE FOR CARAVANS



FROM 2 TO 3 BIKES / 2 E-BIKE

The range of bike carriers for the front of the caravan can be installed on standard A-frame without the need to drill holes.

## FEATURES:

- Installation without drilling holes on standard A-frames
- The Active version, with tensioning strap, allow quick access to the storage compartment
- The upper part pivots forward allowing access to the storage compartment even when bikes are mounted, only when bikes are not mounted for XL A model



Caravan XL A Pro 300

Caravan XL A Pro 200



## MODELS



### CARAVAN ACTIVE

Thanks to the system with tensioning strap, access to the storage compartment is easy and quick. For transporting 2 E-Bikes or 3 standard bikes.



### CARAVAN XL A

Compact and inexpensive, fits almost all Caravan frames (including Hobby and Al-Ko).



### CARAVAN XL A PRO 300

Provided with stainless steel rail support base and reinforced bar, to carry 3 bikes or 2 E-Bikes.



### CARAVAN XL A PRO 200

Equipped with the external rail in two pieces to grant maximum possibility of installation and use. Smaller size for short drawbars.

CHOOSE THE MODEL THAT SUITS YOU

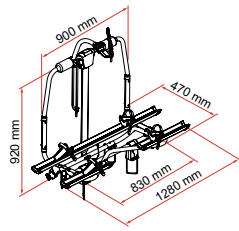

Caravan Active

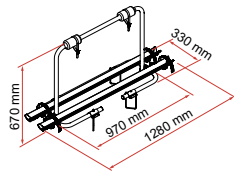

Caravan XL A

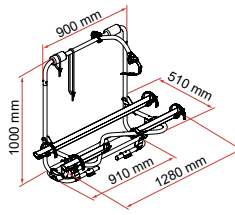

Caravan XL A Pro 300

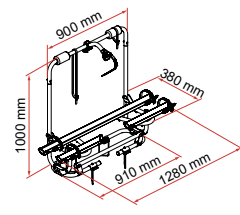

Caravan XL A Pro 200

	Caravan Active	Caravan XL A	Caravan XL A Pro 300 / Deep Black	Caravan XL A Pro 200 / Deep Black
Item No.	02096-05-	02096-23A	02096-91-02096-91A	02096-32-02096-32A
Weight	11,2kg	5,3kg	10,0kg	9,4kg
Max load	50,0kg	50,0kg	50,0kg	50,0kg
Bikes	2 / 3 max 2 E-Bike	2 / 2 max 2 E-Bike	2 / 3 max 2 E-Bike	2 / 2 max 2 E-Bike
Rail type	Rail Premium	Rail Quick Pro	Rail Plus	Rail Plus
Bike-Block	Pro S 3	-	Pro S 3	Pro S 2
Dimensions *	128 x 47 x 92cm	128 x 33 x 67cm	128 x 51 x 100cm	128 x 38 x 100cm
Distance between rails	15cm	15cm	15cm	20cm

\* with rail support base in standard open position and in models with minimum adjustable vertical wheelbase

KIT AL-KO VARIO X

Optional kit Item No. 08723-01- is available for adapting the Carry-Bike to caravans equipped with the Al-Ko Vario X chassis.

	Weight	Item No.
Kit Al-Ko Vario X	0,17kg	08723-01-



WHAT YOU CAN ADD TO YOUR CARRY-BIKE

Bike-Block - See page 154

Rail - See page 152

Accessories - See page 155



**Active - Tensioning strap**  
Makes access to the storage compartment easy and immediate

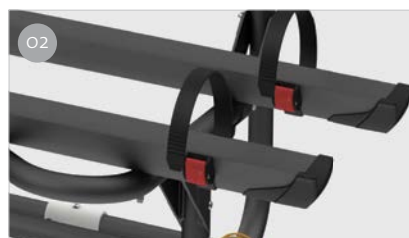

**Rail Plus**  
Design for increased torsion and flexural strength



**Two-piece rail**  
Does not interfere with the caravan's parking systems









Carry-Bike Caravan XL A Pro 300





# Caravan: for the rear wall

SUITABLE FOR CARAVANS



FROM 2 TO 3 BIKES

This special range of bike carriers is designed for mounting on the rear walls of caravans.

## FEATURES:

- Two dedicated models and one to suit every need and requirement
- Aluminium 6060 rail support light and resistant

Caravan Universal



Simple Plus 200



## MODELS



### CARAVAN HOBBY

For mounting on the rear walls of Hobby caravans manufactured after 2003, under the rear window profile. Modification of plastics from blue to black.

### CARAVAN UNIVERSAL

This bike carrier is designed to be mounted on the supporting frame of the caravan (Bürstner, Chateau, etc.). The upper and lower brackets use self-tapping screws, so no through-holes are required. Telescopic frame. Adjustable from 100 to 180cm.

### SIMPLE PLUS 200

Suitable for mounting on caravans with thin and curved rear walls. Installed by using the existing wall reinforcement points. Telescopic frame.



#### Upper brackets

For attaching the bike carrier to the rear wall of your caravan



#### Rail Quick Pro

For quick and secure locking of the wheel to the rail

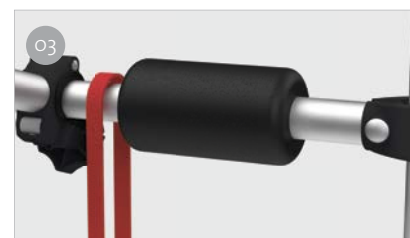

#### Protective bumpers

To protect your bikes from scratches and impacts

CHOOSE THE MODEL THAT SUITS YOU

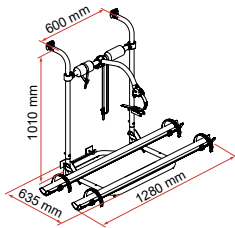

Caravan Hobby

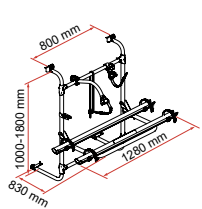

Caravan Universal

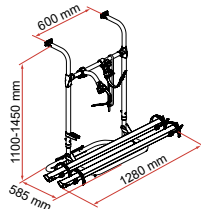

Simple Plus 200

	Caravan Hobby <b>[Restyling]</b>	Caravan Universal	Simple Plus 200
Item No.	02096-77-	02093A76A	02093A36A
Weight	5,6kg	7,5kg	6,4kg
Max load	50,0kg	35,0kg	35,0kg
Bikes	2 / 3 max	2 / 2 max	2 / 2 max
Rail type	Rail Quick Pro	Rail Quick Pro	Rail Quick Pro
Bike-Block	Pro S 3	Pro S 1 / Pro S 3	Pro S 1 / Pro S 2
Dimensions *	128 x 63,5 x 101cm	128 x 83 x 100cm	128 x 58,5 x 110cm
Distance between rails	15cm	30cm	15cm

\* with rail support base in standard open position and in models with minimum adjustable vertical wheelbase

WHAT YOU CAN ADD TO YOUR CARRY-BIKE

Bike-Block

- See page 154

Rail

- See page 152

Accessories

- See page 155



Carry-Bike Caravan Universal





# VW T5 / T6 PRO

SUITABLE FOR CAMPERVANS



FROM 2 TO 4 BIKES / 2 E-BIKE

Specifically for VW T5 and T6, sold fully assembled: simply attach the bike carrier to the vehicle and it will be ready for use immediately.

## FEATURES:

- Shaped rail support: third stop lamp always visible with bike carrier closed
- Solid anchorage to reinforced points of tailgate
- Suitable for vehicles with raised roof too
- You can open the tailgate with the Carry-Bike mounted without bikes

## MODELS



**VW T6 PRO**



**VW T5 PRO**



### Upper brackets T6 Pro

Shaped to optimally follow the line of the vehicle



### Lower brackets

They ensure attachment to the vehicle and fit the line of the tailgate

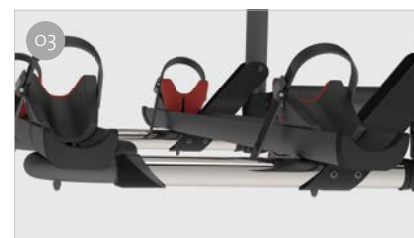

### Telescopic rail support

To fit up to 4 bikes

CHOOSE THE MODEL THAT SUITS YOU

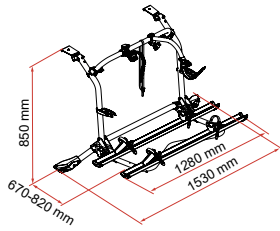

VW T5 Pro

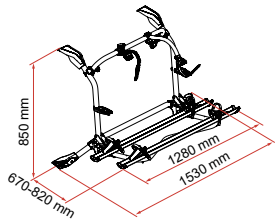

VW T6 Pro

	VW T5 Pro Deep Black	VW T6 Pro Deep Black **
Item No.	02096M71A	02096M08A
Weight	13,0kg	13,0kg
Max load	60,0kg	60,0kg
Bikes	2 / 4 max 2 E-bike	2 / 4 max 2 E-bike
Rail type	Rail Premium	Rail Premium
Bike-Block	Pro S 1 / Pro S 3	Pro S 1 / Pro S 3
Dimensions *	128 x 67 x 85cm	128 x 67 x 85cm
Distance between rails	15cm	15cm
Vehicle compatibility	VW T5 Transporter / Caravelle / Multivan / California (≥ 2003 ≤ 2014)	VW T6 Transporter / Caravelle / Multivan / California (≥ 2014)

\* with rail support base in standard open position and in models with minimum adjustable vertical wheelbase

\*\* T6 Pro version compatible with T6.1

WHAT YOU CAN ADD TO YOUR CARRY-BIKE

Bike-Block - See page 154

Rail - See page 152

Accessories - See page 155





# Campervan VW

SUITABLE FOR CAMPERVANS



FROM 2 TO 4 BIKES / 2 E-BIKE

For all Volkswagen campervan models, Fiamma has designed the perfect Carry-Bike. From Caddy to T2.

## FEATURES:

- All models allow the tailgate to be opened with the bike carrier mounted without bikes
- Telescopic rail support base made of stainless steel AISI 304 and aluminium 6060 for models that carry up to 4 bikes
- Aluminium 6060 rail support base for models that carry 2 / 3 bikes
- Available Deep Black version for VW T5 / T6 D

## MODELS



### VW CADDY

For VW Caddy ≥ 2016 ≤ 2020. The articulated upper structure allows an accurate adjustment of the position of the Bike-Blocks to secure the bikes while the practical lower tensioning system allows the Carry-Bike to be safely fixed to the vehicle.



### VW T5 / T6

For Volkswagen T5 and T6 with single rear door. Suitable for vehicles with raised roof too.



### VW T5 / T6 D

For Volkswagen T5 and T6 with double rear doors.



Carry-Bike VW Caddy



CHOOSE THE MODEL THAT SUITS YOU

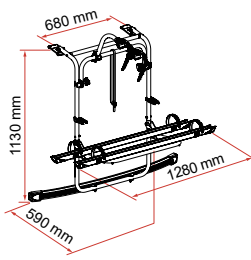

VW Caddy

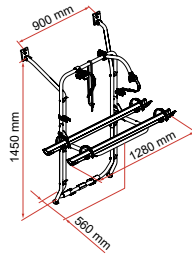

VW T5

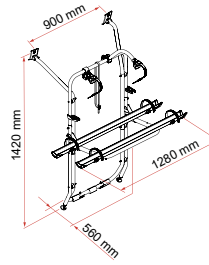

VW T6

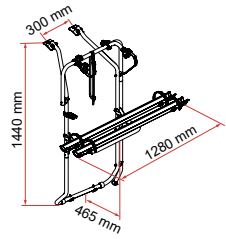

VW T5/T6 D

	VW Caddy	VW T5	VW T6	VW T5 D / T6 D VW T5 D / T6 D Deep Black
Item No.	02096-24-	02096-17-	02096-20-	02096-79- / 02096-79A
Weight	11,7kg	9,1kg	9,2kg	7,1kg
Max load	60kg	60,0kg	60,0kg	35kg
Bikes	2 / 4 max 2 E-Bike	2 / 4 max 2 E-Bike	2 / 4 max 2 E-Bike	2 / 2 max
Rail type	Rail Plus	Rail Plus	Rail Plus	Rail Plus
Bike-Block	Pro S 1 / Pro S 3	Pro S 1 / Pro S 3	Pro S 1 / Pro S 3	Pro S 1 / Pro S 2
Dimensions *	138 x 59 x 113cm	128 x 56 x 145cm	128 x 56 x 142cm	128 x 46,5 x 144cm
Distance between rails	15cm	15cm	15cm	15cm
Vehicle compatibility	VW Caddy / Caddy Maxi ≥ 2016 ≤ 2020	VW T5 Transporter / Caravelle / Multivan / California (≥ 2003 ≤ 2014)	VW T6 Transporter / Caravelle / Multivan / California ≥ 2014)	Versions for double rear door VW T5 (≥ 2003 ≤ 2014) and T6 (≥ 2014) Transporter / Caravelle / Multivan

\* with rail support base in standard open position and in models with minimum adjustable vertical wheelbase

VW Caddy



VW T5



VW T6



VW T5/T6 D



WHAT YOU CAN ADD TO YOUR CARRY-BIKE

Bike-Block - See page 154

Rail - See page 152

Accessories - See page 155

MODELS



**VW T4**

For Volkswagen T4 with single rear door.



**VW T4 D**

For Volkswagen T4 with double rear doors.



**VW T3 (T25)**

For Volkswagen T3 (T25) with single rear door.



**VW T2**

For Volkswagen T2 with single rear door.

CHOOSE THE MODEL THAT SUITS YOU

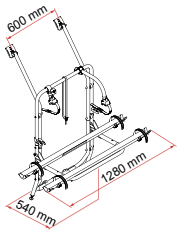

VW T4

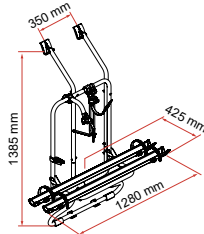

VW T4 D

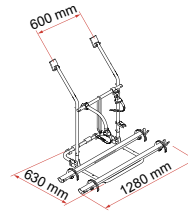

VW T3 (T25)

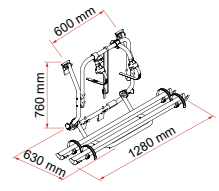

VW T2

	VW T4	VW T4 D	VW T3 (T25)	VW T2
Item No.	02094-18A	02096-22-	02094-19A	02093B63A
Weight	8,3kg	7,9kg	6,5kg	7,0kg
Max load	60,0kg	35,0kg	50,0kg	35,0kg
Bikes	2 / 4 max	2 / 2 max	2 / 3 max	2 / 2 max
Rail type	Rail Quick Pro	Rail Plus	Rail Quick Pro	Rail Quick Pro
Bike-Block	Pro S 1 / Pro S 3	Pro S 1 / Pro S 2	Pro S 1 / Pro S 3	Pro S 1 / Pro S 2
Dimensions *	128 x 54 x 138cm	128 x 42,5 x 138,5cm	128 x 68 x 94,5cm	128 x 63 x 76cm
Distance between rails	15cm	15cm	15cm	15cm
Vehicle compatibility	T4 (≥ 1990 ≤ 2003) also for models with lift roof	Versions for double rear door. T4 (≥ 1990 ≤ 2003)	T3 (≥ 1979 ≤ 1990) also for models with lift roof	T2 (≥ 1967 ≤ 1979) T2 Westfalia

\* with rail support base in standard open position and in models with minimum adjustable vertical wheelbase

VW T4



VW T4 D



VW T3 (T25)



VW T2



WHAT YOU CAN ADD TO YOUR CARRY-BIKE

Bike-Block

- See page 154

Rail

- See page 152

Accessories

- See page 155





Carry-Bike VW T5



# Mercedes Campervan

SUITABLE FOR CAMPERVANS



FROM 2 TO 4 BIKES / 2 E-BIKE



The ideal bike carriers for the Mercedes campervan range, they can carry from two to four bicycles.

## FEATURES:

- All models allow the tailgate to be opened with the bike carrier mounted without bikes
- Mercedes V Class Lift E-Bike: equipped with dropping support rail



## MODELS



### VIANO

For vehicles with single rear door, complete with lighting board.



### VITO

For vehicles with single rear door.



### V CLASS PREMIUM

For vehicles with single rear door, the rail support is mounted in the standard or lowered position. Lower version must be used with license plate bar with lights.



### V CLASS LIFT E-BIKE

E-Bike version of V Class Premium for 2 bikes, with rail support base that drops by 77cm. Complete with license plate bar with lights.

CHOOSE THE MODEL THAT SUITS YOU

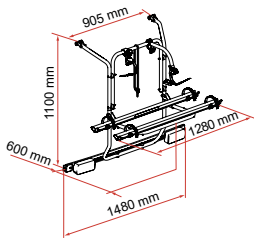

Mercedes Viano

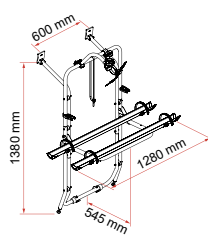

Mercedes Vito

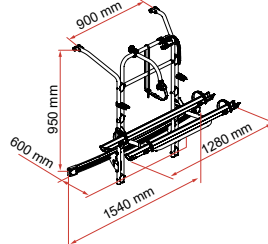

Mercedes V Class Premium \*

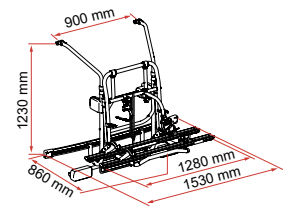

Mercedes V Class Lift E-Bike

	Mercedes Viano	Mercedes Vito	Mercedes V Class Premium *	Mercedes V Class Lift E-Bike
Item No.	02093B75A	02096-02-	02096-14-	02095A15A
Weight	10,0kg	9,2kg	18,3kg	20,5kg
Max load	50,0kg	60,0kg	60,0kg	60,0kg
Bikes	2 / 3 max	2 / 4 max 2 E-Bike	2 / 4 max 2 E-Bike	2 E-Bike
Rail type	Rail Quick Pro	Rail Plus	Rail Plus	Rail Premium
Bike-Block	Pro S 1 / Pro S 3	Pro S 1 / Pro S 3	Pro S 1 / Pro S 3	Pro S 1 / Pro S 3
Dimensions **	148 x 60 x 110cm	128 x 54,5 x 138cm	154 x 60 x 95cm	153 x 86 x 123cm
Distance between rails	15cm	15cm	15cm	23cm
Vehicle compatibility	Mercedes Viano II series, Vito II series and Marco Polo II series with single rear door (≥ 2003 ≤ 2013)	Mercedes Viano Vito I series and Marco Polo I series with single rear door (≥ 1996 ≤ 2003)	Mercedes V Class III series, Vito III series and Marco Polo III series with a single tailgate (≥ 2014)***	Mercedes V Class III series, Vito III series and Marco Polo III series with a single tailgate (≥ 2014)***

\* This version allows the installation of the rail support base in two different positions, one standard and one lower to make it easier to load the bikes. Lower version must be used with the License Plate Carrier, which has the license plate holder bar and regulation lights.

\*\* with rail support base in standard open position and in models with minimum adjustable vertical wheelbase

\*\*\* not suitable for AMG-equipped models

SAFE MOUNTING

In the Viano and Mercedes V Class versions, the upper structure of the bike carrier is screwed to the vehicle chassis through the holes provided by the parent company, avoiding any problems of incorrect positioning during installation.



WHAT YOU CAN ADD TO YOUR CARRY-BIKE

Bike-Block - See page 154

Rail - See page 152

Accessories - See page 155



**Lighting board**  
To travel safely

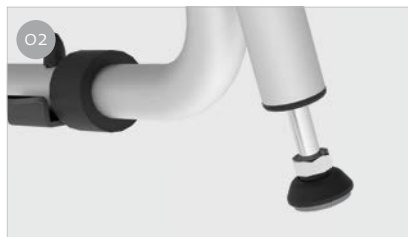

**Stabilisation system**  
To increase the safety of your bike carrier



**Curved bottom fixing-bar**  
For greater adhesion to the tailgate

# Ford Campervan

SUITABLE FOR CAMPERVANS



FROM 2 TO 4 BIKES / 2 E-BIKE



Specific models for Ford minivans, choose the one best suited to your vehicle!

## FEATURES:

- All models allow the tailgate to be opened with the bike carrier mounted without bikes
- Telescopic rail support base made of stainless steel AISI 304 and aluminium 6060 for models that carry up to 4 bikes
- Aluminium 6060 rail support base for models that carry 2 / 3 bikes

## MODELS

E-Bike   
new  
20  
25



### FORD CUSTOM V710

For Ford Custom  $\geq$  2023 vehicles.  
Mounting of the rail support in 3 positions: standard, middle and lower\*.  
Bike-Block support tube can be installed in 2 different positions, for easy use depending on the position of the rail support base.  
Curved bottom fixing-bar for greater adhesion to the tailgate.

E-Bike 



### FORD CUSTOM NUGGET / NUGGET PLUS HIGHROOF

For Ford Transit Custom Nugget / Nugget Plus with raised roof (highroof).  
Adheres to the lower part of the tailgate thanks for the curved profile that follows the shape of the vehicle.

E-Bike 



### FORD CUSTOM

For vehicles with single tailgate and also for models with lift roof. Adheres to the lower part of the tailgate thanks for the curved profile that follows the shape of the vehicle.



### FORD TRANSIT

For vehicles with single rear door.

\* (for the last two, the license plate bar with lights must be used)



CHOOSE THE MODEL THAT SUITS YOU

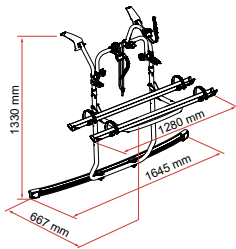

Ford Custom V710

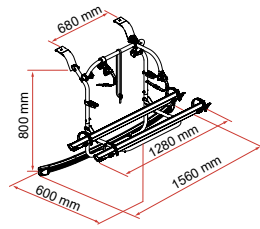

Ford Transit Custom Nugget /  
Nugget Plus (Highroof) Deep Black

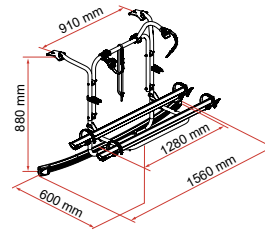

Ford Custom Deep Black

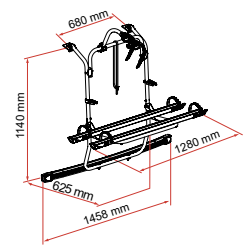

Ford Transit

Ford Custom V710

Ford Transit Custom Nugget /  
Nugget Plus (Highroof)  
Deep Black

Ford Custom  
Deep Black

Ford Transit

Item No.	02096-34A	02096-07A	02096-06A	02093A60A
Weight	11kg	8,4kg	8,6kg	7,1kg
Max load	60,0kg	50,0kg	50,0kg	50,0kg
Bikes	2 / 4 max 2 E-Bike	2 / 3 max 2 E-Bike	2 / 3 max 2 E-Bike	2 / 3 max
Rail type	Rail Plus	Rail Plus	Rail Plus	Rail Quick Pro
Bike-Block	Pro S1 / Pro S3	Pro S1 / Pro S3	Pro S1 / Pro S3	Pro S1 / Pro S3
Dimensions *	164,5 x 133 x 66,7cm	156 x 60 x 80cm	156 x 60 x 88cm	128 x 53 x 150cm
Distance between rails	15cm	15cm	15cm	15cm
Vehicle compatibility	Ford Transit / Tourneo Custom single tailgate (≥ 2023- H1) also for models with lift roof	Ford Transit Custom Nugget / Nugget Plus (≥ 2012 ≤ 2023) raised roof (highroof)	Ford Transit / Tourneo Custom single tailgate (≥ 2012 ≤ 2023- H1) also for models with lift roof	Ford Transit MK3-MK4- MK5-MK6-MK7 (≥2000 ≤ 2011 - H1)

\* with rail support base in standard open position and in models with minimum adjustable vertical wheelbase

WHAT YOU CAN ADD TO YOUR CARRY-BIKE

Bike-Block

- See page 154

Rail

- See page 152

Accessories

- See page 155



Carry-Bike Ford Transit Custom Nugget / Nugget Plus

# Campervans

SUITABLE FOR CAMPERVANS



FROM 2 TO 4 BIKES / 2 E-BIKE

Whatever your campervan, Fiamma has the solution for you.

## FEATURES:

- Version dedicated to PSA group camper vans
- All models allow the tailgate to be opened with the bike carrier mounted without bikes
- Telescopic rail support base made of stainless steel AISI 304 and aluminium 6060 for models that carry up to 4 bikes
- Aluminium 6060 rail support base for models that carry 2 / 3 bikes

## MODELS



E-Bike



E-Bike



E-Bike

### VIVARO - TRAFIC - TALENTO

For vehicles with single rear door.  
The licence plate carrier with control lighting is suggested.

### VIVARO - TRAFIC - TALENTO D

For vehicles with double rear door,  
structure allowing visibility of the third stop.

### PSA

Adheres to the lower part of the tailgate thanks to the curved profile that follows the shape of the vehicle.



01

**Upper brackets**  
Designed to follow the shape of the vehicle



02

**Stabilisation system**  
To increase the safety of your bike carrier



03

**Curved bottom fixing-bar**  
For greater adhesion to the tailgate

## + WHAT YOU CAN ADD TO YOUR CARRY-BIKE

Bike-Block - See page 154

Rail - See page 152

Accessories - See page 155



CHOOSE THE MODEL THAT SUITS YOU

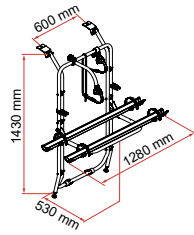

Vivaro - Trafic - Talento

Vivaro - Trafic - Talento

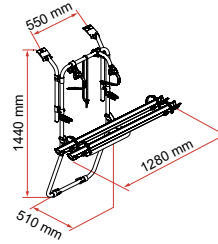

Vivaro - Trafic - Talento D

Vivaro - Trafic - Talento D \*

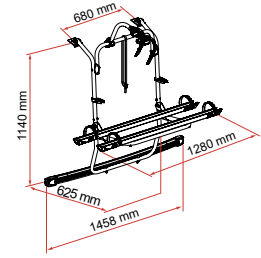

PSA

PSA / Deep Black

Item No.	02096-72-	02096-74-	02096-28- / 02096-28A
Weight	9,1kg	7,3kg	11,3kg
Max load	60,0kg	50,0kg	60,0kg
Bikes	2 / 4 max 2 E-Bike	2 / 2 max 2 E-Bike	2 / 4 max 2 E-Bike
Rail type	Rail Plus	Rail Plus	Rail Plus
Bike-Block	Pro S 1 / Pro S 3	Pro S 1 / Pro S 3	Pro S 1 / Pro S 3
Dimensions **	128 x 53 x 143cm	128 x 51 x 144cm	145,8 x 62,5 x 114cm
Distance between rails	15cm	15cm	15cm
Vehicle compatibility	Renault Trafic II series / Opel Vivaro A / Vauxhall Vivaro A / Nissan Primastar I-II series (≥ 2001 ≤ 2014 - H1) Renault Trafic III series / Nissan NV300 / Fiat Talento (≥ 2014 - H1) Opel Vivaro B / Vauxhall Vivaro B (≥ 2014 ≤ 2018 - H1)	Renault Trafic II series / Opel Vivaro A / Vauxhall Vivaro A / Nissan Primastar I-II series (≥ 2001 ≤ 2014 - H1) Renault Trafic III series / Nissan NV300 / Fiat Talento (≥ 2014 - H1) Opel Vivaro B / Vauxhall Vivaro B (≥ 2014 ≤ 2018 - H1)	Citroën Jumpy III gen. - Spacetourer ≥ 2016 - H1 Opel / Vauxhall Vivaro C - Zafira Life 2019 - Vivaro Life ≥ 2019 - H1 Peugeot Expert III gen. - Traveller ≥ 2016 - H1 Toyota ProAce II - ProAce Verso ≥ 2016 - H1 Also for models with lift roof

\* version for vehicles with double rear doors

\*\* with rail support base in standard open position and in models with minimum adjustable vertical wheelbase



Carry-Bike PSA



# Frame

SUITABLE FOR VAN CONVERSIONS



FOR 2 E-BIKES OR 3 STANDARD BICYCLES



One bike carrier and 3 different dedicated frames for each type of vehicle (Ducato, Sprinter and Crafter), which can be purchased separately.

## FEATURES:

- Stainless steel AISI 304 rail support base
- The geometric configuration of the Carry-Bike allows the rear door of the vehicle to be opened even with the bikes mounted
- Deluxe ladder can be mounted on the left hand door

## COMPOSITION

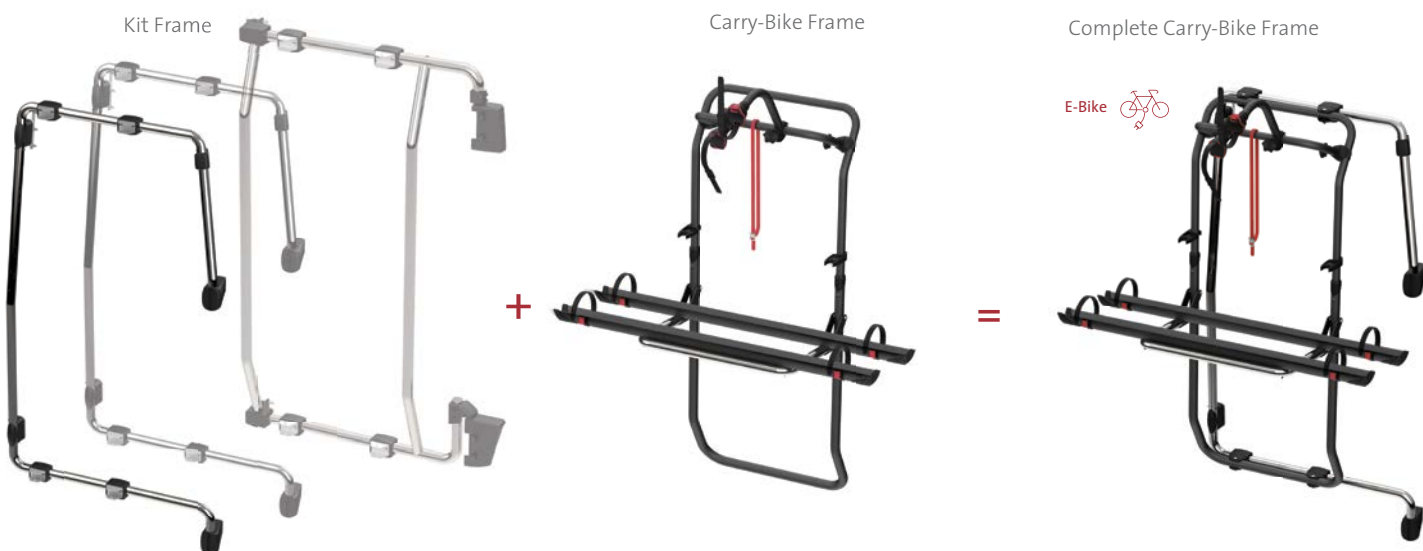

## MODELS



### FRAME DUCATO

For Fiat Ducato, Citroën Jumper, Peugeot Boxer, allows mounting of the rail support in 3 positions: standard, middle and low\*. Also suitable for vehicles with protruding windows.



### FRAME SPRINTER

For Mercedes Sprinter ≥ 2018 - high roof and super high, allows mounting of the rail support in 3 positions: standard, middle and low\*.



### FRAME CRAFTER

For VW Crafter II gen. and MAN TGE. It allows mounting of the rail support in 3 positions: standard, middle and low\*.

\* (for the last two, the license plate bar with lights must be used)

**MODULARITY**

Kit Frame	Item No.		Carry-Bike	Item No. Deep Black / Alu		Complete Carry-Bike
Kit Frame Ducato	08753-01-					Carry- Bike Frame Ducato
Kit Frame Sprinter	08753-02-	+	Carry-Bike Frame	02096-35A / 02096-35-	=	Carry- Bike Frame Sprinter
Kit Frame Crafter	08753-03-					Carry- Bike Frame Crafter

**CHOOSE THE MODEL THAT SUITS YOU**

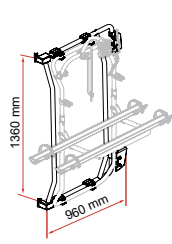

Kit Frame Ducato

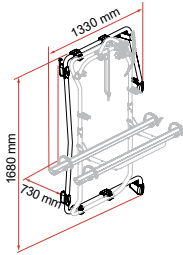

Kit Frame Sprinter

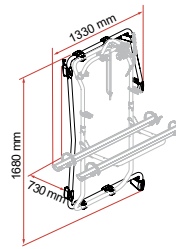

Kit Frame Crafter

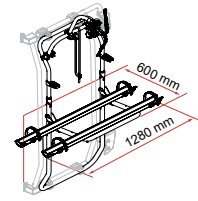

Carry-Bike Frame

	Kit Frame Ducato	Kit Frame Sprinter	Kit Frame Crafter	Carry-Bike Frame / Deep Black
Item No. Deep Black / Alu	08753-01-	08753-02-	08753-03-	02096-35A / 02096-35-
Weight	10,8kg	9,5kg	9,5kg	9,4kg
Max load	-	-	-	50kg
Bikes	-	-	-	2 / 3 max 2 E-Bike
Rail type	-	-	-	Rail Plus
Bike-Block	-	-	-	Pro S 1 / Pro S 3
Dimensions	96 x 136cm	133 x 168cm	133 x 168cm	128 x 60cm
Distance between rails	-	-	-	15cm
Vehicle compatibility	Fiat Ducato III-IV series / Citroen Jumper II-III series / Peugeot Boxer II-III series (≥ 2006 - H2/H3) Not suitable for vehicles with 270° hinge system	Mercedes Sprinter ≥ 2018 - high roof and super high roof. Not suitable for vehicles with 270° hinge system	VW Crafter II series / MAN TGE (≥ 2017 - H3 / H4) Not suitable for vehicles with 270° hinge system	-

\* with rail support base in standard open position and in models with minimum adjustable vertical wheelbase

**WHAT YOU CAN ADD TO YOUR CARRY-BIKE**

Bike-Block - See page 154

Rail - See page 152

Accessories - See page 155



**Kit Frame**  
Stainless steel frame, available in three different models



**Secure fastening**  
Using the hinges of the vehicle



**Stainless steel rail support base**  
For supporting up to 3 standard bikes or 2 E-Bikes









Carry-Bike Frame Ducato  
Rail support positions: standard



# DJ Series

SUITABLE FOR VAN CONVERSIONS



FOR 2 STANDARD BICYCLES

One bike carrier for all models and dedicated fixing bars for each type of vehicle (Ducato, Sprinter, Crafter and Transit) that can be purchased separately.

**FEATURES:**

- Aluminium 6060 rail support base
- Deluxe ladder can be mounted on the left hand door
- Anodised aluminium version also available
- Mounting of the rail support in 3 positions: standard, middle and low, for the last two, the licence plate bar with lights must be used

**COMPOSITION**



**RAIL SUPPORT BASE POSITION**

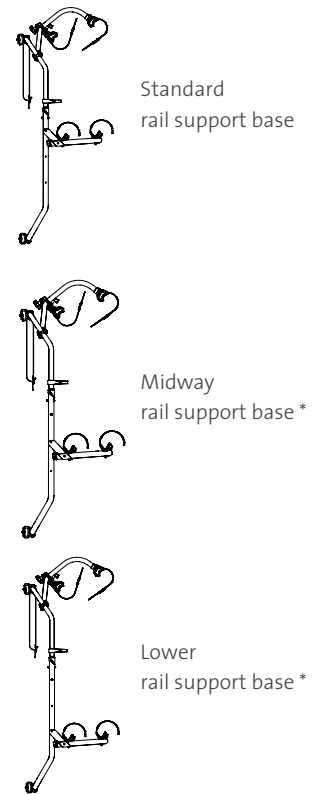

\* requires the use of the licence plate bar with light

**MODULARITY**

Kit Bars		Carry-Bike		Complete Carry-Bike
Kit Bars DJ Ducato ≥ 06				Carry- Bike DJ Ducato
Kit Bars DJ Sprinter ≥ 06 / Crafter ≥ 06 ≤ 16	+	Carry-Bike DJ	=	Carry- Bike DJ Sprinter / Crafter
Kit Bars DJ Crafter ≥ 17				Carry- Bike DJ Crafter
Kit Bars DJ Transit ≥ 14				Carry- Bike DJ Transit



**Rail Quick Pro**  
For quick and secure locking of the wheel to the rail



**Fixing Bar**  
For fast and safe mounting



**Bike-Block Support**  
Adjustable, for easy attachment to bicycles



CHOOSE THE MODEL THAT SUITS YOU

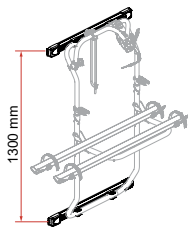

Kit Bars DJ  
Ducato ≥ 06

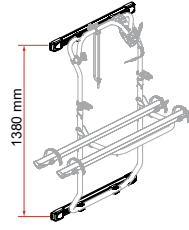

Kit Bars DJ Sprinter ≥ 06 /  
Crafter ≥ 06 ≤ 16

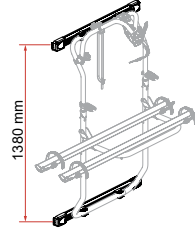

Kit Bars DJ  
Crafter ≥ 17

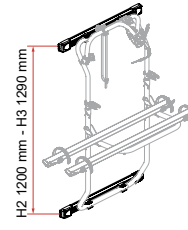

Kit Bars DJ  
Transit ≥ 14

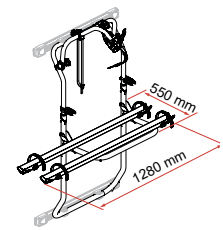

Carry-Bike DJ

	Kit Bars DJ Ducato ≥ 06	Kit Bars DJ Sprinter ≥ 06 / Crafter ≥ 06 ≤ 16	Kit Bars DJ Crafter ≥ 17	Kit Bars DJ Transit ≥ 14	Carry-Bike DJ
Item No. Deep Black / Alu	08754-01A / 08754-01-	08754-02A / 08754-02-	08754-03A / 08754-03-	08754-04A / 08754-04-	02096-26A / 02096-26-
Weight	2,8kg	2,6kg	2,6kg	2,6kg	7,8kg
Max load	-	-	-	-	35kg
Bikes	-	-	-	-	2 / 2 max
Rail type	-	-	-	-	Rail Quick Pro
Bike-Block	-	-	-	-	Pro S 1 / Pro S 3
Dimensions *	130cm	138cm	138cm	H2 120cm / H3 129cm	128 x 55cm
Distance between rails	-	-	-	-	23cm
Vehicle compatibility	Fiat Ducato III-IV series / Citroën Jumper II-III series / Peugeot Boxer II-III series (≥ 2006 - H2/H3)	Mercedes Sprinter II series / Freightliner Sprinter / Dodge Sprinter (≥ 2006 ≤ 2018 - H2) Mercedes Sprinter III series / Freightliner Sprinter / Dodge Sprinter (≥ 2018 - H2) VW Crafter I gen. (≥ 2006 ≤ 2016 - H2)	VW Crafter II series / MANTGE (≥ 2017 - H3 / H4)	Ford Transit (≥ 2014 - H2 / H3)	-

\* with rail support base in standard open position and in models with minimum adjustable vertical wheelbase

CARRY-BIKE DJ DUCATO

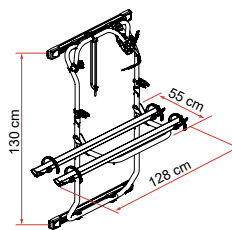

Carry-Bike DJ Ducato  
Deep Black

	Carry-Bike DJ Ducato Deep Black
Item No.	02096A26A
Weight	10,6kg
Max load	35kg
Bikes	2 / 2 max
Rail type	Rail Quick Pro
Bike-Block	Pro S 1 / Pro S 3
Dimensions *	128 x 55 x 130cm
Distance between rails	23cm
Vehicle compatibility	Fiat Ducato III-IV series / Citroën Jumper II-III series / Peugeot Boxer II-III series (≥ 2006 - H2/H3)

\* with rail support base in standard open position and in models with minimum adjustable vertical wheelbase

DJ DUCATO

For the DJ Ducato Deep Black version, it is possible to purchase the complete Carry-Bike consisting of Kit Bars + Carry-Bike DJ, in one package.

WHAT YOU CAN ADD TO YOUR CARRY-BIKE

Bike-Block - See page 154

Rail - See page 152

Accessories - See page 155



# Van conversions

SUITABLE FOR VAN CONVERSIONS



FOR 2 BIKES



These bike carriers are installed on the right-hand door of the vehicle, leaving the left-hand door free for the possible installation of a Deluxe ladder to access the roof of the vehicle.

## FEATURES:

- Installation with Fixing Bar for 200 DJ Ducato, with standard fixing brackets for 200 D
- Solid and light aluminium 6060 structure
- Rear door opens even with bikes mounted

## MODELS



### 200 DJ DUCATO < 2006

For right rear door, mounting with Fixing Bar, equipped with Rail Premium.



### 200 D

For van conversions with double rear doors, wheelbase variable from 58 to 62cm to adapt to different rear doors. Vertical wheelbase from 90 to 118cm.

## CHOOSE THE MODEL THAT SUITS YOU

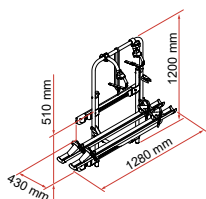

200 DJ Ducato &lt; 2006

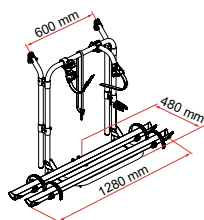

200 D

	200 DJ Ducato < 2006	200 D
Item No.	02093A65A	02096-16-
Weight	9,0kg	6,9kg
Max load	35kg	35kg
Bikes	2 / 2 max	2 / 2 max
Rail type	Rail Premium	Rail Quick Pro
Bike-Block	Pro S 1 / Pro S 2	Pro S 1 / Pro S 2
Dimensions *	128 x 43 x 120cm	128 x 48 x 90cm
Distance between rails	15cm	15cm
Vehicle compatibility	Fiat Ducato II series/ Citroën Jumper I series/ Peugeot Boxer I series (≥ 2000 ≤ 2006 - H2) Mercedes Sprinter I series / Mercedes Benz T1N (≥ 1995 ≤ 2006 - H2)	Fiat Ducato I series / Citroën C25 / Peugeot J5 (≥ 1981 ≤ 1994 - H1/H2) Fiat Ducato II series/ Peugeot Boxer I series/ Citroën Jumper I series (≥ 1994 ≤ 1999 - H2) Ford Transit MK3-MK4-MK5-MK6-MK7 (≥ 1987 ≤ 2014 - H1/H2/H3) Ford Transit MK8 (≥ 2014 - H3)

\* with rail support base in standard open position and in models with minimum adjustable vertical wheelbase

## WHAT YOU CAN ADD TO YOUR CARRY-BIKE

Bike-Block

- See page 154

Rail

- See page 152

Accessories

- See page 155

# SUV

SUITABLE FOR SUV



UP TO 3 BIKES



Thanks to the fixing strap, these simple and effective bike carriers fit perfectly in SUVs, off-road vehicles and cars.

## FEATURES:

- Aluminium 6060 rail support solid and light
- Fastening straps for maximum freedom of fastening on the vehicle (except fibreglass)

## MODELS



### BACKPACK

The Carry-Bike with universal straps is easily installed on all minivans. Not suitable for fibreglass rear doors. No tools are required for installation, 6 superior Heavy Duty Quick Lock straps secure the bike carrier to the vehicle.



### BACKPACK 4x4

Bike carrier for SUV with rapid installation to the rear spare tyre thanks to the sturdy straps. Before mounting remove the rigid cover of the spare tyre.

## CHOOSE THE MODEL THAT SUITS YOU

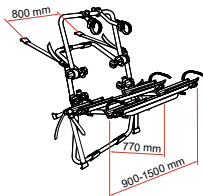

Backpack

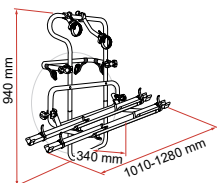

Backpack 4x4

	Backpack	Backpack 4x4
Item No.	02093A38-	02093B38-
Weight	8,0kg	7,8kg
Max load	50kg	35kg
Bikes	2 / 3 max	2 / 2 max
Rail type	Rail Quick C	Rail Strip C
Bike-Block	Pro S1 / Pro S3	Pro S1 / Pro S2
Dimensions *	90 x 77cm	101 x 34 x 94cm
Distance between rails	15cm	15cm

\* with rail support base in standard open position and in models with minimum adjustable vertical wheelbase

## WHAT YOU CAN ADD TO YOUR CARRY-BIKE

Bike-Block - See page 154

Rail - See page 152

Accessories - See page 155



# Garage

SUITABLE FOR MOTORHOMES



FROM 2 TO 4 BIKES

The locker of your motorhome is the perfect place to store your bikes and transport them safely: just install the special Fiamma Carry-Bike!

## FEATURES:

- Different models of bike carriers to install in the garage facility to transport from 2 up to 4 bikes safely
- Easy to install

## MODELS



### GARAGE PLUS

Fixes to the floor. With optional accessories it can carry up to 4 bikes. When not in use, it folds up and takes up only 22cm.



### GARAGE STANDARD

Bike carrier with lower section fastened to the floor and Bike-Block fixed to the wall or to the roof. When folded it gives more floor space, it carries up to 3 bikes.



### GARAGE SLIDE PRO BIKE

Anodized aluminium 6060 sliding bike carrier for the motorhome garage. Height adjustable. For transporting 2 E-Bikes or 2 standard bikes.



### GARAGE PACK-PLUS

Complete kit with fixing structure for bikes and Organizer line storage.



CHOOSE THE MODEL THAT SUITS YOU

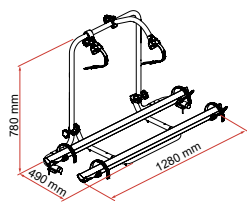

Garage Plus

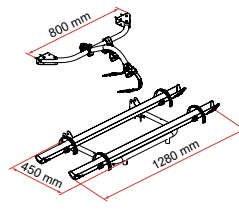

Garage Standard

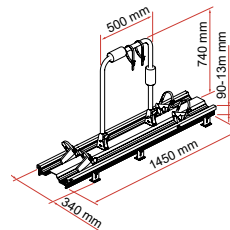

Garage Slide Pro Bike

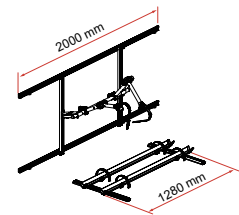

Garage Pack Plus

	Garage Plus	Garage Standard	Garage Slide Pro Bike	Garage Pack Plus
Item No.	02093A78A	02096A54A	04822-05-	98655B911
Weight	5,6kg	4,8kg	9,9kg	10,5kg
Max load	60,0kg	50,0kg	50,0kg	-
Bikes	2 / 4 max	2 / 3 max	2 / 2 max 2 E-Bike	2 / 3 max
Rail type	Rail Quick Pro	Rail Quick Pro	-	Rail Quick Pro
Bike-Block	Pro S 1 / Pro S 3	Pro S 1 / Pro S 3	Strip	Pro S D1 / Pro S D2
Dimensions	128 x 49 x 78cm	128 x 45cm	145 x 34 x 74cm (closed)	-

WHAT YOU CAN ADD TO YOUR CARRY-BIKE

Bike-Block	- See page 154	Rail	- See page 152	Accessories	- See page 155
------------	----------------	------	----------------	-------------	----------------



Garage Pack Plus



# Moto

SUITABLE FOR MOTORHOMES AND VAN CONVERSIONS



Motorbike carrier systems ideal for installation in motorhomes with garage facilities or on vans.

## FEATURES:

- Adaptable to different types of vehicles
- Easy to install



### CARRY-MOTO

Motorbike-carrier in aluminium for garage. The chute connects easily onto the main structure to facilitate loading of the motorbike. Supplied as standard with 2 click strips.



### CARRY-MOTO PRO

Motorbike-carrier in aluminium for garage. The pull-out chute is coated with an anti-slip band. Supplied as standard with 2 click strips. Height adjustable.

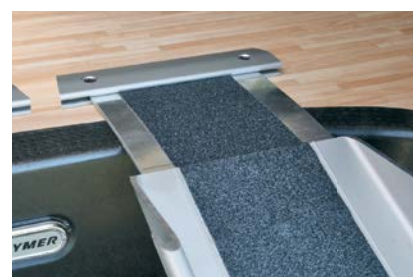

### CARRY-RAMP

Motorbike aluminium ramp, suitable for motorhome doors or on the floor of the garage facility.



### MOTO WHEEL CHOCK FRONT

Wheel chock for front wheel. Complete with kit for fixing on wood surfaces. Supplied as standard with 2 click strips.



### MOTO WHEEL CHOCK REAR

Wheel chock for rear wheel. The fixing knobs allow the motorbike to be locked quickly and safely. Supplied as standard with rails for floor fixing.

### CARRY-RAMP

By combining two pieces of the Carry-Ramp you can create a system of ramps to load quads, powered wheelchairs or wheelchairs.

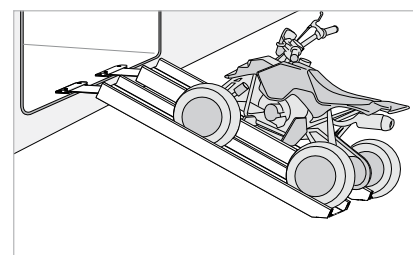

CHOOSE THE MODEL THAT SUITS YOU

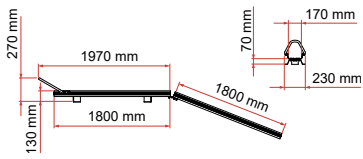

Carry-Moto

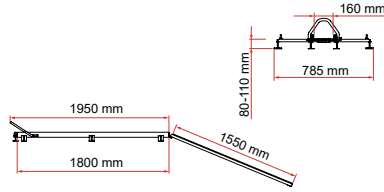

Carry-Moto Pro

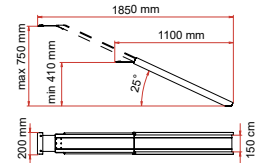

Carry-Ramp

	Carry-Moto	Carry-Moto Pro	Carry-Ramp
Item No.	02095-01-	02095-03-	02095-04-
Weight	12,2kg	15,4kg	7kg
Max load	200kg	200kg	130kg
Telescopic	-	●	●
Ramp angle	variable	variable	fixed 25°
Wheel chock front	●	●	●
Wheel chock rear	-	-	●
Fastening straps	●	●	-
Wheel width max	14cm	16cm	15cm
Chute extension	180cm	155cm	175cm

● Standard    ● Optional

CHOOSE THE MODEL THAT SUITS YOU

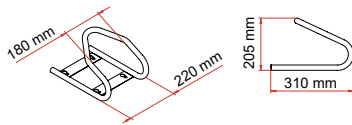

Moto Wheel Chock Front

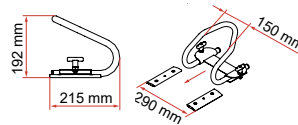

Moto Wheel Chock Rear

	Moto Wheel Chock Front	Moto Wheel Chock Rear
Item No.	05781-01-	05800-01-
Weight	2,4kg	2,8kg
Wheel width max	18cm	15cm



Carry-Moto Pro





# Rail

SUITABLE FOR MOTORHOMES, CARAVANS, VAN CONVERSIONS AND CAMPERVANS, 4x4, AND SUV



Choose the fitting rail model that best suits your bike and your needs: they fit all Carry-Bike models!



## RAIL PLUS / RAIL PLUS XL

Rail Plus, technically better performing, higher resistance against torsion and bending due to its new geometry and improved material distribution. Larger section for transporting different types of bicycles.

Standard version 128cm long, XL version 139cm.



## RAIL QUICK PRO

Sturdy rail with reinforced base delivered with Quick-Safe straps. It is interchangeable with the previous Rail Quick version.



## RAIL QUICK C

Telescopic rail that can be adjusted to the desired extension, with 2 Quick-Safe straps. Ideal to limit rail overhang. It can be installed on almost all Carry-Bikes.



## RAIL PREMIUM / PREMIUM XL

Rail with increased structure size, with sliding bike-lock support, for quicker and more practical fixing. The XL version is 139cm longer and is suited for particularly long E-Bikes and bikes with wheelbase greater than 125cm.

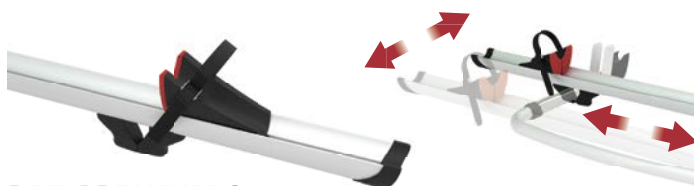

## RAIL PREMIUM S

Rail with increased structure size sliding on the Carry-Bike rail support, it can move in both direction and has adjustable centre-to-centre distance.



## RAIL PREMIUM S FAT BIKE

Model based on Premium S rail for transporting modern Fat Bikes with tyres up to 4,8" wide. Comfortable 40cm strap with fast and safe ratchet coupling.





**KIT PREMIUM S**

Turn Quick and Premium rails into Premium S rails. Quick installation by removing the standard hooks. Now rails can slide horizontally, to be adapted to the dimensions of the different bikes.

2x



**KIT RAIL PREMIUM 48**

Optional fourth two-part rail for the Carry-Bike VW T5 Pro and T6 Pro models.



**KIT UPGRADE E-BIKE**

If you already have a Fiamma Pro Series bike carrier, thanks to the E-Bike Upgrade Kit you can transform it into a bike carrier for your electric bike.



**CHOOSE THE MODEL THAT SUITS YOU**

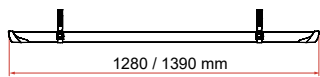

Rail Plus / Plus XL

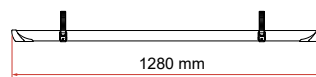

Rail Quick Pro

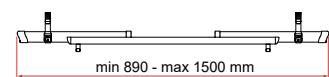

Rail Quick C

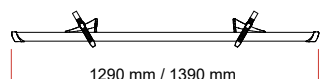

Rail Premium / Premium XL

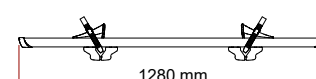

Rail Premium S / Premium S Fat Bike

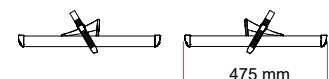

Kit Rail Premium 48

	Colour	Weight	Hooking type	Right/Left sliding	Forward-back sliding	Length	Item No.
Rail Plus	Anodised / Deep Black	1,0kg	Quick Safe	●	●	128cm	98656M566 / 98656M567
Rail Plus XL	Anodised / Deep Black	1,1kg	Quick Safe	●	●	139cm	98656M588 / 98656M589
Rail Quick Pro	Anodised / Deep Black	1,0kg	Quick Safe	●	●	128cm	98656-993 / 98656M358
Rail Quick C	Anodised	1,2kg	Quick Safe	●	●	89-150cm	98656-369
Rail Premium	Anodised / Deep Black	1,3kg	Premium Quick	●	●	128cm	98656M131 / 98656M150
Rail Premium XL	Anodised / Deep Black	1,9kg	Premium Quick	●	●	139cm	98656M132 / 98656M153
Rail Premium S	Anodised / Deep Black	1,7kg	Premium Quick	●	●	128cm	98656M133 / 98656M152
Rail Premium S Fat Bike	Anodised / Deep Black	2,0kg	Premium Quick	●	●	128cm	98656M146 / 98656M151
Kit Premium S	Deep Black	0,3 kg	-	-	-	-	98656M134
Kit Rail Premium 48	Anodised / Deep Black	1,2 kg	Premium Quick	●	●	47,5cm	98656M087 / 98656M147
Kit Upgrade E-Bike*	Anodised	5,5 kg	Premium Quick	●	●	128cm	98656M137

● Standard      ● Optional (by using Kit Premium S)

\* Only for Carry-Bike < 2023

**RAILS**



Rail Plus



Rail Quick Pro

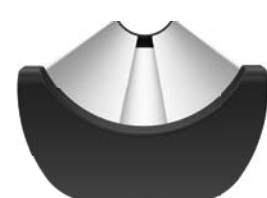

Rail Premium



# Bike-Block Pro S

SUITABLE FOR MOTORHOMES, CARAVANS, VAN CONVERSIONS, CAMPERVANS, 4x4 AND SUV



Upgrade of the Fiamma system to secure your bike to the Carry-Bike during transport. Thanks to the adjustable joint, it adapts to all types of bicycles. It is equipped with a secure holding device with clamp, scratch-proof rubber insert and anti-theft safety loop.

**FEATURES:**

- Improved ergonomics thanks to frontally- positioned knob
- Integrated scratch-proof support base with rubber protection for integrated bike hooking
- In D versions, the practical central joint makes hooking the bikes even simpler
- Aluminium tube curved to make it easier to attach the bike

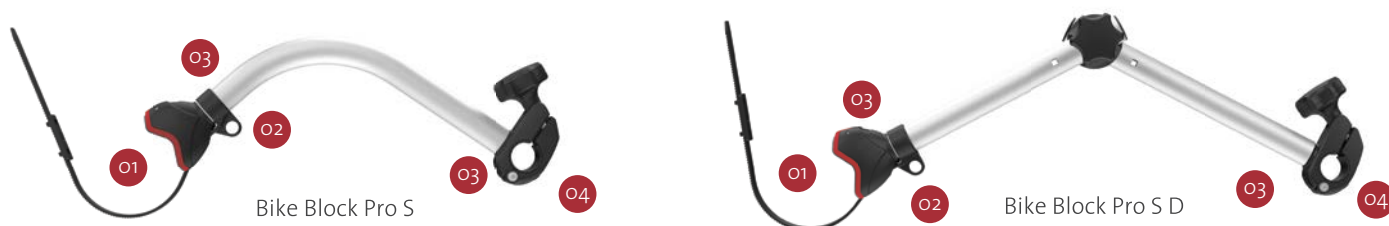

**Bike support base**  
For round or oval tubes  
Ø 25 - 100mm



**Safety buttonhole**  
To use an anti-theft cable when  
fixing the bikes

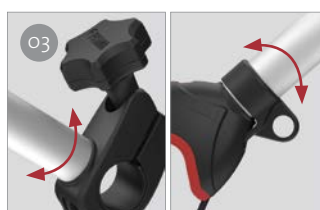

**360° rotation**  
The clamp and bicycle locking  
system can rotate 360°



**Locking clamp**  
For Ø 30 - 35mm pipes

**CHOOSE THE MODEL THAT SUITS YOU**

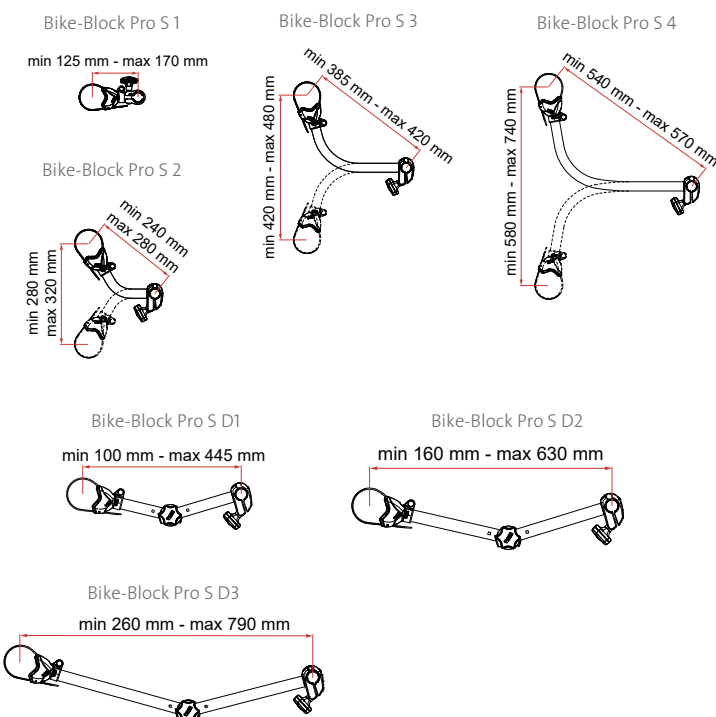

	Colour	Weight	Item No.
Bike-Block Pro S 1 D30	Anodised / Deep Black	0,2 kg	08831-01-08831-01A
Bike-Block Pro S 1 D35 *		0,2 kg	08831G01-08831G01A
Bike-Block Pro S 2		0,3 kg	08831A01-08831A01A
Bike-Block Pro S 3		0,4 kg	08831B01-08831B01A
Bike-Block Pro S 4		0,5 kg	08831C01-08831C01A
	Colour	Weight	Item No.
Bike-Block Pro S D1	Anodised / Deep Black	0,6kg	08831D01- / 08831D01A
Bike-Block Pro S D2		0,7kg	08831E01- / 08831E01A
Bike-Block Pro S D3		0,8kg	08831F01- / 08831F01A

\*for Carry-Bike Pro / ProN, Motor Lift 77, Lift 77, VW T6 Pro, VW T5 Pro, Mercedes V Class Lift E-Bike





# Locking System

SUITABLE FOR MOTORHOMES, CARAVANS, VAN CONVERSIONS, CAMPERVANS, 4x4 AND SUV



Are you ready for a particularly adventurous trip? Secure your bikes with these securing systems, suitable for both Fiamma Carry-Bike and other bike carrier brands.

## + CHOOSE THE MODEL THAT SUITS YOU



### QUICK-SAFE

Sliding strap for locking the wheel to the rail, equipped with an immediate release button. Can be installed only on original Fiamma reinforced rails. Pack of 1 piece.



### STRIP

Kit of 2 strips, 39cm long, with stainless steel AISI 304 buckle suitable for almost all bike carrier brands. Pack of 2 pieces.



### SECURITY STRIP

200cm security strip, with stainless steel AISI 304 buckle, 200cm long and 1.3cm wide. Suitable for all bike carriers. Pack of 1 piece.



### BIKE FRAME ADAPTER

Additional aluminium 6060 bar for easy fixing of bikes without standard centre bar, ladies' bikes and BMXs.



### CABLE-LOCK

Anti-theft plastic-coated 250cm steel cable, with incorporated padlock. Delivered as standard with 2 keys. Pack of 1 piece.



### KIT RAIL SUPPORT BASE BLOCK

Bracket locking kit for Carry-Bike Pro/N and Pro C/N  $\geq$  2023. Prevents knocks caused by potholes, bumps and road irregularities, minimising stress. Pack of 2 pieces. Standard on Carry-Bike Pro Pro/N and Pro C/N  $\geq$  2025.

## ☰ CHOOSE THE MODEL THAT SUITS YOU

	Weight	Item No.		Weight	Item No.
Quick-Safe	0,1kg	98656B386	Bike Frame Adapter	0,5kg	06602-01-
Strip Red	0,1kg	98656-320	Cable-Lock	0,1kg	98656-338
Strip Black	0,1kg	98656-318	Kit Rail Support Base Block	0,1kg	98656M545
Security Strip	0,1kg	98656-419			



# Installation Kit

SUITABLE FOR MOTORHOMES, CARAVANS, VAN CONVERSIONS, CAMPERVANS, 4x4 AND SUV



Mounting bars and accessories to install your Fiamma Carry-Bike on your vehicle. Choose the one best suited to your vehicle and bike carriers!

## + ADD TO YOUR CARRY-BIKE



### FIXING-BAR CARRY-BIKE

Pair of 240cm long reinforcement bars ideal for vehicles with rear walls not equipped with internal reinforced points.



### SUPPORT BAR KIT

Kit of two pre-drilled anodized aluminium bars to fix the bike carrier to the walls of motorhomes. Complete with through screws, internal fixing brackets and end caps for more flexibility of installation: the screws can slide over the bar to be adjusted to the different wheel bases.



### LICENCE PLATE CARRIER

Licence plate carrier bar in aluminium with regulation lights and 13-pole socket for quick connection to the vehicle's electrical system. It is used when the rail support covers the lights and the licence plate of the vehicle. The bar turns 90° to be positioned correctly even when the rail support is folded up.



### DUST GUARD

Guard to prevent the accumulation of debris inside the Fixing-Bar.

Suitable for:

- Fixing Bar Carry-Bike
- Carry-Bike 200 DJ Ducato > 2006 / 200 DJ Ducato < 2006
- Carry-Bike 200 DJ Sprinter
- Carry-Bike Mercedes Viano
- Carry-Bike Ford Custom
- Carry-Bike PSA
- Carry-Bike Mercedes V Class Premium / V Class Lift E-Bike
- Deluxe DJ Ducato / H3
- Deluxe DJ

## CHOOSE THE MODEL THAT SUITS YOU

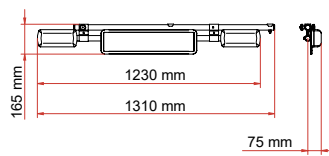

Licence Plate Carrier

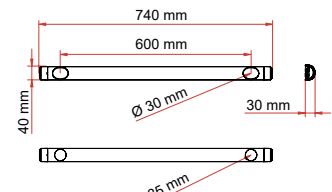

Kit Support Bar

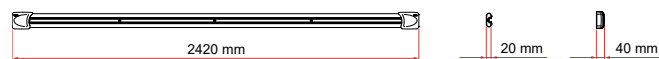

Fixing-Bar Carry-Bike

	Colour	Length	Weight	Item No.
Fixing-Bar Carry Bike	Anodised	242cm	5,5kg	98656A474
Kit Support Bar	Anodised	74cm	1,2kg	98656B682
Licence Plate Carrier	Anodised / Deep Black	131cm	2,4kg	06146C01- / 06146C01A
Dust Guard	Black	240cm	0,3kg	07752-01-



# Rear boxes

SUITABLE FOR MOTORHOMES, CARAVANS AND VAN CONVERSIONS



The Fiamma rear luggage boxes are installed on top of the bike carrier support rail with the kit already included. Solid and strong, they withstand stress, impacts and adverse weather conditions.

## FEATURES:

- In ABS (Ultra-Box) or strong tear-resistant polyester
- Three dimensions: from 300 to 500 litres
- The Cargo Back soft luggage bag is equipped with a transparent material pocket, with Velcro, to insert the protruding load sign



Ultra-Box 320



Ultra-Box 360



Ultra-Box 500

## ULTRA-BOX

Made of high resistance ABS to last over time. With stainless steel closing lock and key and internal aluminium profile it is also equipped with a net to secure the transported items. Available with 320, 360 and 500-litre capacities. Can only be installed on Carry-Bike for motorhomes.



## CARGO BACK

Soft luggage bag made of waterproof, tear-proof polyester. With transparent pocket for protruding loads and perimeter zip on the lid, it is ideal for transporting chairs, camping and sports accessories and is quick and easy to install. The attachment system means that it now also fits to the Carry-Bike DJ and Carry-Bike Frame models.



## KIT FRAME CARGO BACK

Aluminium tube and plastic structure to be inserted inside the Cargo Back to keep it tensioned in any load situation.

## CHOOSE THE MODEL THAT SUITS YOU

	Volume	Weight	External dimensions	Internal dimensions	Item No.
Ultra-Box 320 *	320l	12,0kg	100x53x70cm	88,5x46x62cm	04147-01-
Ultra-Box 360 *	360l	14,0kg	147x38x70cm	133,5x30x58cm	02801-01-
Ultra-Box 500 *	500l	17,0kg	147x53x70cm	133,5x46x62cm	04148-01-
Cargo Back	285l	1,4kg	120x70x35cm	-	08846-01-
Kit Frame Cargo Back	-	1,2kg	119x69x32cm	-	06106-01-

\* Not suitable for Carry-Bike with offset rails



# Bike covers and accessories

SUITABLE FOR MOTORHOMES AND CARAVANS



FROM 2 TO 4 BIKES



Protect your bikes with the range of lightweight, water-proof polyester reinforced resin bike covers.

## FEATURES:

- Bi-colour finish
- Equipped with a transparent material pocket, with Velcro, to insert the protruding load sign (excluding Bike Cover Caravan model)



### BIKE COVER SUPER

Elastic bottom closure and metal hooks, 300D polyester fabric with polyurethane backing, maximum opacity and weather resistance. Equipped with transparent pocket for protruding load sign and bag for convenient storage.



### BIKE COVER

Closure with elastic band at the bottom and metal hooks. Equipped with transparent pocket for protruding load sign and bag for comfortable storage.



### BIKE COVER PREMIUM

For complete bike protection. Closes with side zipper and rear Velcro. Equipped with transparent pocket for protruding load sign and bag for comfortable storage.



### BIKE COVER CARAVAN

Specific for bike carriers mounted on the A-frame of caravans. It is placed on top of the bikes already mounted on the rail support. Drawstring-type closure with a cable clip. Equipped as standard with bag for comfortable storage.



### EASY DRY

Practical drying rack for installation on the support rail of the bike rack. The foldable structure makes it possible to travel with the drying rack mounted.



### ALU SIGNAL

Type-approved sign, in light aluminium, for signalling protruding loads. Mandatory in Italy. Dimensions: 50x50cm.



### PLASTIC SIGNAL

Non type-approved plastic sign for signalling protruding loads, with four reflectors. Dimensions: 50x50cm.

#### CHOOSE THE MODEL THAT SUITS YOU

	Bikes covered	Vehicle type	Closing system	Weight	Item No
Bike Cover Super *	4	Motorhomes	Elastic band with hooks	1,4kg	08845A01-
Bike Cover Premium *	4		Zippers	0,9kg	08208B01-
Bike Cover 4 *	4		Elastic band with hooks	1,0kg	08208A01-
Bike Cover 2-3 *	2 / 3		0,9kg	08208-01-	
Bike Cover Caravan	2	Caravans	Elastic band with lock	0,8kg	08208C01-

\* Not suitable for bike carriers whose dimensions (or the bikes carried) exceed that of the vehicle or if they cover the lights

	Material	Dimensions	Weight	Item No.
Easy Dry	-	100x60cm	1,2kg	06306-01-
Alu Signal	Aluminium	50x50cm	0,7kg	98782-010
Plastic Signal	Plastic	50x50cm	0,2kg	98782-005

## COMFORT

To make you feel at home in every stop and move, Fiamma has created a complete range of devices and accessories that will equip your vehicle with every comfort. Aesthetically appealing and functional in every condition, the right accessories to make your journey more comfortable. Each solution is designed to occupy as little space as possible while giving you maximum performance.

# Comfort throughout the journey





## ROOFLIGHTS

Different types of rooflights, to adapt to each type of vehicle.



## LIGHTING

Find the right lighting among the various proposals for indoor and outdoor LEDs.



## WATER

Manage the water and use it in the best possible way in your vehicle with the special tanks and pumps.



## LEVELLING SYSTEMS

Various models of level and accessories to safely stabilize your vehicle.



## ORGANISATION

Arrange everything in the most suitable place, to have everything always in order.



## SAFETY

Take big and small precautions to make your holiday safer.



## LADDERS

Indoors and outdoors, different models to best suit your vehicle.



## HYGIENE

Keep the environment clean and hygienic thanks to portable toilets and specific sanitary accessories.



## VEHICLE COVERS

Protect your vehicle from the weather.

## MIX

Various products and accessories to complete your Comfort range.



# Vent 28 F

SUITABLE FOR MOTORHOMES, CARAVANS, VAN CONVERSIONS AND CAMPERVANS



A small rooflight, it is suitable for smaller rooms and provides excellent interior lighting. It can be motorised with the Turbo-Vent 28 F kit.

## FEATURES:

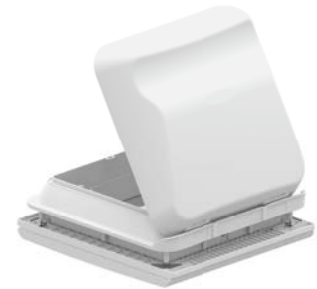

- Internal and external frame in neutral white colour
- 28x28cm
- Discreet and elegant design
- Cover available in 2 finishes: White and Crystal
- Standard mosquito net
- Motorised (optional)

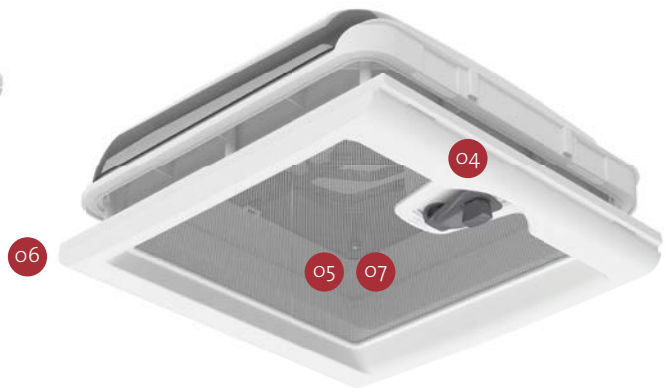

Vent 28 F White



## COVER FINISH

-  White (opaque white)
-  Crystal (tinted transparent)

- |   |   |  |
|---|---|--|
| <p><b>01 Aerodynamic</b><br/>Cover design to optimise air resistance and acoustic comfort</p> | <p><b>02 Sandwich assembly</b><br/>Quick installation without needing to cut more holes in the roof of your vehicle</p> | <p><b>03 Permanent ventilation</b><br/>For constant exchange of air</p>            |
| <p><b>04 Opening system</b><br/>With handy handwheel</p>                                      | <p><b>05 Mosquito net</b><br/>Made of aluminium, easily removable for cleaning</p>                                      | <p><b>06 Slim frame</b><br/>Minimum vertical dimensions on the vehicle ceiling</p> |
|   |   | <p><b>07 Motorised</b><br/>With the Kit Turbo-Vent 28 F (optional)</p>             |



### CHOOSE THE MODEL THAT SUITS YOU

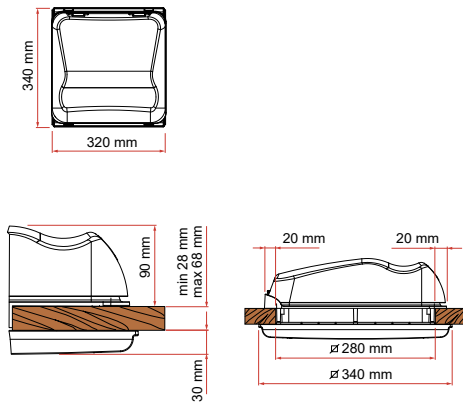

	Vent 28 F White	Vent 28 F Crystal
Item No.	07902-02-	07902-02D
Cover	White	Crystal
Weight	1,8kg	1,8kg
Dimensions	28x28cm	28x28cm
Outside dimensions	32x34x9cm	32x34x9cm
Internal dimensions	31x34x3cm	31x34x3cm
Inside light	25x25cm	25x25cm
Roof thickness (min - max)	2,8 - 5,0cm	2,8 - 5,0cm
Roof thickness with Kit Extension min.-max.	5,0 - 6,8cm	5,0 - 6,8cm

### WHAT YOU CAN ADD TO YOUR VENT 28 F

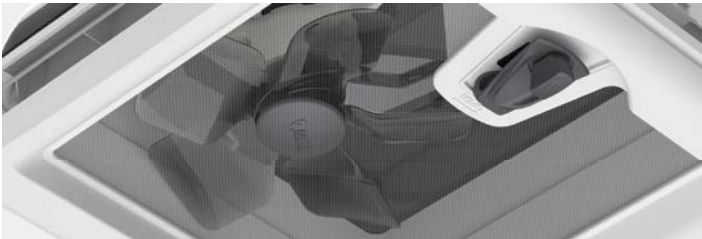

#### **KIT TURBO-VENT 28 F**

Optional kit to motorise your Vent 28 F. The kit can be added at any time after purchase.

	Kit Turbo-Vent 28 F
Item No.	07903-02-
Weight	0,5kg
Power supply	12V
Power consumption	25W
Maximum input	1,9A
Maximum air flow	9m <sup>3</sup> /min
Fan diameter	18cm
Permanent air flow	50cm <sup>2</sup>





# Vent / Turbo-Vent

SUITABLE FOR MOTORHOMES, CARAVANS, VAN CONVERSIONS AND CAMPERVANS



Ideal for motorhomes, caravans and van conversions, this rooflight is also available in a motorised version and allows constant air circulation.

## FEATURES:

- Internal and external frame in neutral white colour
- 40x40cm
- Cover available in 2 finishes: White and Crystal
- Standard mosquito net, optional blind
- Motorised versions also available



Vent White



**01 Aerodynamic**  
Cover design to optimise air resistance and acoustic comfort

**02 Installation**  
With through screws, wide and reinforced frame

**03 Permanent ventilation**  
For constant exchange of air

**04 Opening system**  
With handy handwheel

**05 Mosquito net**  
Fibreglass as standard

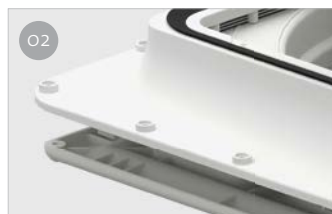

 CHOOSE THE MODEL THAT SUITS YOU
**VENT**

Rooflight without motor equipped with permanent air flow ventilation and mosquito net.

**TURBO-VENT**

Classic rooflight with 12V DC variable speed motor.

Polar Control  
function

Touch function

**TURBO-VENT PREMIUM**

Rooflight with motor where all functions are activated by a simple finger touch. Convenient electronic interface with signal LEDs.

Polar Control  
function

Touch function

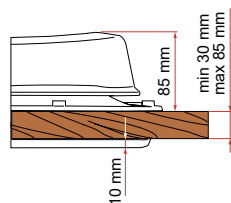
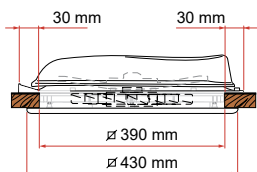
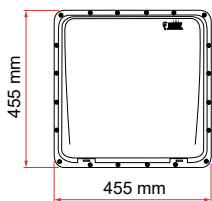

	Vent	Turbo-Vent	Turbo-Vent Premium
Item No.	04329B02- / 04329B02D	03624F02- / 03624F02D	03624H02- / 03624H02D
Cover	White / Crystal	White / Crystal	White / Crystal
Weight	2,8kg	4,6kg	4,6kg
Dimensions	40x40cm	40x40cm	40x40cm
Outside dimensions	45,5x45,5x8,5cm	45,5x45,5x8,5cm	45,5x45,5x8,5cm
Internal dimensions	43x43x1cm	43x43x1cm	43x43x1cm
Roof thickness (min - max)	3,0 - 5,0cm	3,0 - 4,5cm	3,0 - 5,0cm
Roof thickness with Kit Extension min.-max.	5,1 - 8,5cm	4,5 - 8,5cm	5,1 - 8,5cm
Feeding tension	-	12 V	12V
Absorbed power	-	36W	36W
Min. electric input	-	0,3A	0,3A
Max electric input	-	3A	3A
Maximum air flow	-	35m <sup>3</sup> /min	35m <sup>3</sup> /min

# Vent F Pro

SUITABLE FOR MOTORHOMES, CARAVANS, VAN CONVERSIONS AND CAMPERVANS



Ideal for motorhomes, caravans and vans. It can be motorised with 2 different types of Turbo-Vent F Kits.

## FEATURES:

- Internal and external frame in neutral white colour
- 40x40cm
- Elegant and stylized design
- Mosquito net and pleated blinds as standard
- Motorised



## MODEL

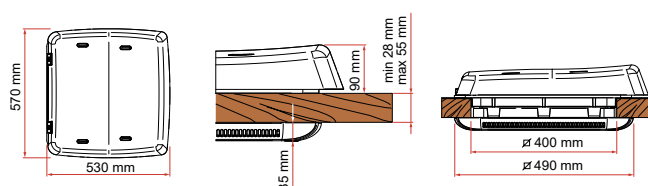

	Cover	Weight	Dimensions	Outside dimensions	Internal dimensions	Inside light	Roof thickness (min - max)	Item No.
Vent F Pro	Crystal	4,7kg	40x40cm	56,6x53,1x9,2cm	49x48,6x3,5cm	34,4x34,4cm	2,8 - 5,5cm	07380-02-

## ADD TO YOUR VENT F PRO



### KIT TURBO-VENT F PREMIUM

Equipped with "Touch" electronic control unit and Polar Control\* thermostat as standard.



### KIT TURBO-VENT F

Standard version equipped with Polar Control\* thermostat.

\* Polar Control function automatically activates the ventilation depending on the difference among measured ambient temperature, required temperature and outdoor temperature.

	Feeding tension	Power consumption	Min. absorption / Maximum input	Maximum air flow	Polar Control function	Touch function	Weight	Item No.
Kit Turbo-Vent F Premium	12V	36W	0,3A - 3A	35m <sup>3</sup> /min	●	●	2,0kg	07501-01-
Kit Turbo-Vent F	12V	36W	0,3A - 3A	35m <sup>3</sup> /min	●	-	2,0kg	07501A01-





# Vent 50

SUITABLE FOR MOTORHOMES AND CARAVANS





A large rooflight, which can be opened on all four sides “pantograph opening” thanks to the convenient handles. Allows permanent ventilation of the vehicle.

## FEATURES:

- Internal and external frame in new neutral white colour
- 50x50cm
- Cover available in 2 finishes: White and Crystal
- Standard mosquito net and blinds

## COVER FINISH

-  White (opaque white)
-  Crystal (tinted transparent)



01 Opening  
Pantograph type

02 Handles  
Locking anti-theft device

03 Permanent ventilation  
For constant exchange of air

04 Mosquito net and blind  
Supplied as standard, fibreglass mosquito net and aluminium blind to reflect heat

05 Sandwich assembly  
Quick installation without needing to cut more holes in the roof of your vehicle



## MODEL

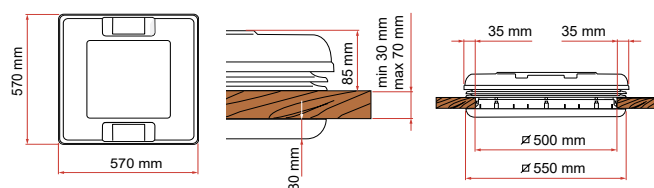

	Cover	Weight	Dimensions	Outside dimensions	Internal dimensions	Roof thickness (min - max)	Item No.
Vent 50 White	White	4,7kg	50x50cm	57x57x8,5cm	55x55x3cm	3,0 - 7,0cm	01668-02-
Vent 50 Crystal	Crystal	4,7kg	50x50cm	57x57x8,5cm	55x55x3cm	3,0 - 7,0cm	01668-02D



# Turbo-Kit

SUITABLE FOR MOTORHOMES, CARAVANS AND VAN CONVERSIONS



An additional fan for your vehicle, quick and easy to install on almost all models of rooflights. Simple to connect to the electrical system, thanks to the 12Vdc power cable.

## FEATURES:

- It can be installed on Fiamma 50x50cm rooflights, 40x40cm rooflights of other brands up to 50x70cm
- Composed of a ventilation system with fan and telescopic hangers
- Complete with supply for cigarette lighter socket and 12Vdc power supply cable for the motorhome's electric supply
- It can also be powered by batteries

## FEATURES

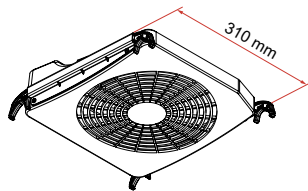
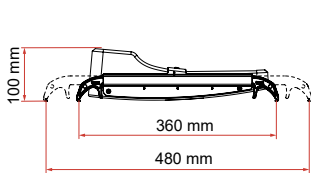

Polarity inverter:  
from fan to aspirator

	Power supply	Power consumption	Min. absorption / Maximum input	Maximum air flow	Fan diameter	Dimensions	Weight	Item No.
Turbo-Kit	12V	4W	0,2A - 0,33A	7,2m <sup>3</sup> /min	24cm	31x36-48cm	1,3kg	98683-059







# Kit Frame Ducato

SUITABLE FOR VAN CONVERSIONS



Specially designed interface to allow the Vent 28 F, Vent 40 and Turbo-Vent rooflights to be installed on Ducato, adapting them to the surface of the vehicle.

## FEATURES:

- Made of durable ASA material
- They allow the installation of rooflights 28x28 and 40x40 on Ducato
- Available as an optional accessory
- Easy installation

## MODELS

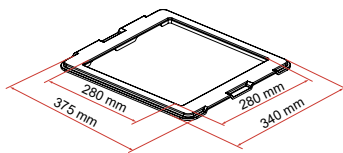

Kit Frame 28 Ducato

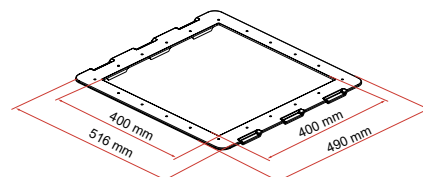

Kit Frame 40 Ducato

	Dimensions	Weight	Item No.
Kit Frame 28 Ducato	37,5 x 34cm	0,3kg	08635-01-
Kit Frame 40 Ducato	49x49cm	0,4kg	08636-01-

## KIT FRAME 28 DUCATO

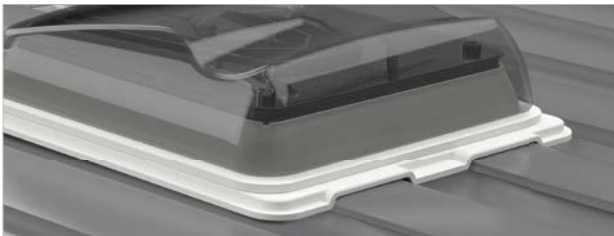

## KIT FRAME 40 DUCATO

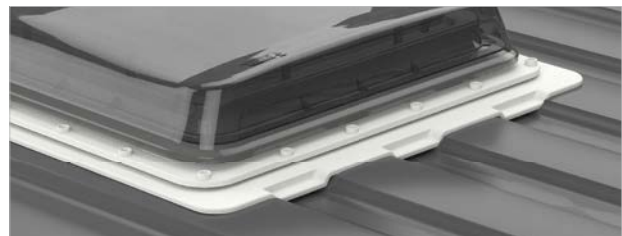





# Accessories

To make your Fiamma rooflight even more efficient, we have designed a range of accessories.



## SPOILER UNIVERSAL

This universal spoiler reduces vibration and noise from the rooflight. It can be shortened to fit to the different rooflight dimensions (from 110cm to 28cm). Complete with side aerodynamic end caps. Can be attached with suitable adhesives (Sika).



## SPOILER 40

Designed to fit the non-aerodynamic 40x40cm rooflights. Can be attached with suitable adhesives (Sika).



## THERMO VENT 40

Vent insulation that reflects sun light and prevents cold air from entering. It can be installed on all 40x40cm rooflights.



## ROLLO VENT 40

Heat-reflecting aluminium roller blind for installation on 40x40cm Vent rooflights. Permanent ventilation thanks to its side inlets. Easy installation without drilling the vehicle.

### MODELS

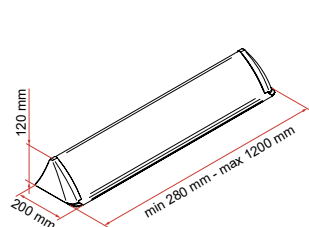

Spoiler Universal

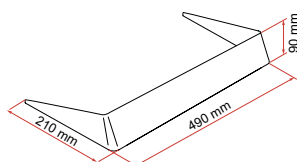

Spoiler 40

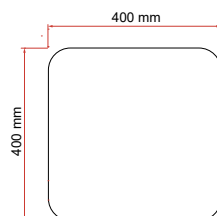

Thermo Vent 40

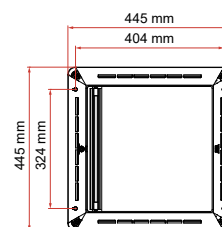

Rollo Vent 40

	Spoiler Universal	Spoiler 40	Thermo Vent 40	Rollo Vent 40
Item No.	06289-01-	03585-01-	03650A01-	06310-02-
Weight	1,4kg	0,3kg	0,1kg	0,1kg
Dimensions	28-120x20x12cm	49x21x9cm	40x40cm	44,5x44,5cm



FIAMMASTORE

CARRY-BIKE

COMFORT





# LEDs for awnings

SUITABLE FOR MOTORHOMES, CARAVANS, VAN CONVERSIONS AND CAMPERVANS



Lots of solutions to illuminate your space using the arms and rails of the awning. All systems are LED, to guarantee an excellent level of lighting and very low power consumption.

## FEATURES:

- Average LED duration 30,000 hours
- LED COB\* for a homogenous and better distribution of neutral light 4,000 K, excellent for reading and relaxing
- 12V power supply

## MODELS



### RAFTER LED

Restyling featuring easier and more practical awning attachment, COB LEDs\* and power supply via jack connector and cigarette lighter (12V socket).

Suitable for: F45/F80s.



### RAFTER LED CARAVANSTORE

Specifically, for CaravanStore awning. Distinct restyling with more convenient and effective awning attachment, COB LEDs\* and power supply via jack connector and cigarette lighter (12V socket).

Suitable for: CaravanStore, CaravanStore ZIP.



### RAFTER LED VAN

Specific for F43van and F40van, equipped with COB LEDs\*. Fast attachment directly to the arms of the awning, for an optimally taut fabric at all times. Power supply via jack and cigarette lighter (12V).

Suitable for: F43van 270, F40van and F45s 260.



### AWNING ARMS LED

4 COB LEDs\* lights (2 pairs) that are easily attached to the articulated arms of the awnings and remain mounted allowing the awning to be closed completely. Complete with 5m of cable for quick connection.

Suitable for: F45s/L, F45eagle, F80s/L, F65eagle, F65L.



### KIT AWNING LED

Installation by simply pushing on the front bar, for a permanent fixing. It is composed of two 12V 9 LED low consumption light strips and 5m of cable.

Suitable for: F45s/L, F45eagle.



### KIT LED STRIP AWNING F80

Specific for F80s, F80L and F65L awnings consisting of a 5m LED COB\* sticky strip and PVC lens, which can be easily shortened. To be inserted into the internal profile of the front and case box (for F80s and F80L only).

Suitable for: F80s/L, F65L, F65eagle.

\* COB = Chip On Board. COB LED strips are LED strips that create homogeneous lines of light without the classic dotted effect





	Kit Cable Guide	Kit Cable Rail
Item No.	98655-903	98655-856
Weight	0,1kg	0,1kg

## MODELS

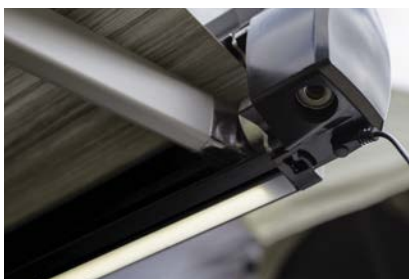

### KIT LED STRIP AWNING F43

COB LED\* strip for insertion in the F43van awning case box. Available in the standard size of 2.5m.

\* COB = Chip On Board. COB LED strips are LED strips that create homogeneous lines of light without the classic dotted effect



### LED AWNING CASE

COB LED\* light bar to be inserted in the special case box housing of F45s, F45L and F70 winch awnings. Delivered as standard in the length of 2.5m. The optional 50cm kit is available. Suitable for: F45s/L.

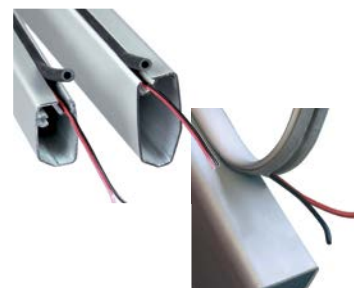

### KIT CABLES

For hiding electrical cables in the awning. Can be used with Awning Arms LED (1 kit) and Awning LED kit (2 kits).

**Kit Cables Guide:** kit of 2 flexible profiles ideal for awnings with arms provided with guide preset for the passing of cables.

**Kit Cables Rail:** kit of 2 compact rails, ideal for all the awnings with arms not preset for the passing of the electrical cables.

	F45s	F45s campervan	F45L	F45eagle	F43van	F80s	F80L	F65eagle	F40van	CS / CS ZIP
Rafter LED	•	•	•			•				
Rafter LED Caravanstore										•
Rafter LED Van	•**	•**			•***				•	
Awning Arms LED [Restyling]	•	•	•	•		•	•	•		
Kit Awning LED	•	•	•	•						
Kit LED Strip Awning (F80)						•	•	•		
Kit LED Strip Awning (F43van)					•					
LED Awning Case / LED Awning Case 50 [Restyling]	•		•	•						

\*\* F45s 260  
\*\*\* F43van 270

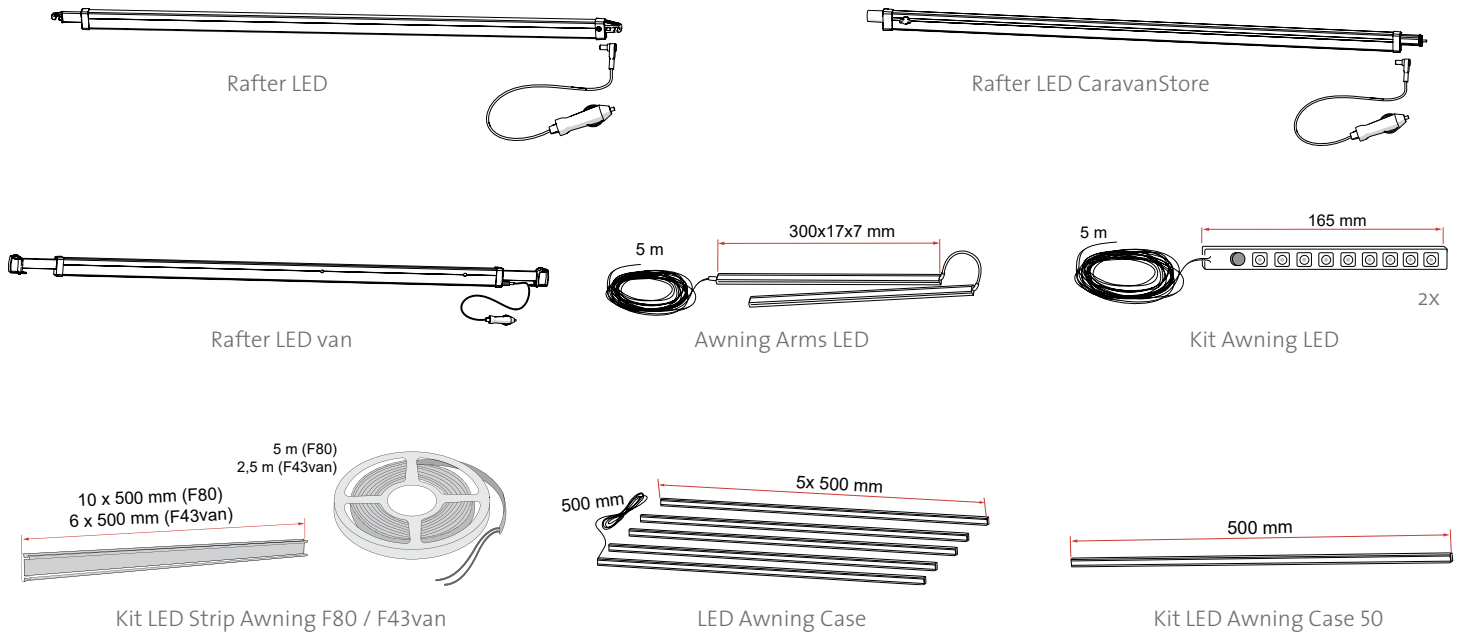
 CHOOSE THE MODEL THAT SUITS YOU

	Rafter LED	Rafter LED CaravanStore	Rafter LED Van	Awning Arms LED [Restyling]	Kit Awning LED	Kit LED Strip Awning F80	Kit LED Strip Awning F43van	LED Awning Case [Restyling]	Kit LED Awning Case 50 [Restyling]
Item No. / Deep Black	98655A850	98655A902	98655A134	98655A849	98655-471	98655Z171	98655Z172	98655A914 98655H914	98655A915 98655H915
LED Colour	Neutral white	Neutral white	Neutral white	Neutral white	Cold white	Neutral white	Neutral white	Neutral white	Neutral white
Tone	4000° k	4000° k	4000° k	4000° k	6500° k	4000° k	4000° k	4000° k	4000° k
Light Cone Angle	120°	120°	120°	120°	120°	120°	120°	120°	120°
Lumen	1228	1228	1228	1228	170	5115	2558	510 / bar	510
N° LED	COB	COB	COB	COB	9	COB	COB	COB	COB
Feeding tension	12V	12V	12V	12V	12V	12V	12V	12V	12V
Absorbed power	13W	13W	13W	13,2W	2,4W	55W	27W	5,5W / bar	5,5W
Electric input	1,25A	1,25A	1,25A	1,1A	0,20A	4,58A	2,25A	0,46A / bar	0,46A
IP degree of protection	IP 65	IP 65	IP 65	IP 54	IP 54	IP 65	IP 65	IP 54	IP 54
Weight	1,4kg	1,4kg	1,4kg	0,3 kg	0,13kg	0,3kg	0,3kg	0,25kg	0,06 kg







Kit LED Strip Awning F80





# LED for outdoors and garage

SUITABLE FOR MOTORHOMES, CARAVANS, VAN CONVERSIONS AND CAMPERVANS



To illuminate your outdoor space and your garage. All systems are LED, ensuring optimum lighting and very low power consumption.

## FEATURES:

- Average LED duration 25,000 hours
- Super Bright LEDs,  $\varnothing$  5mm

## MODELS



### LED AWNING LIGHT

External LED light for awnings, which can be installed under the awning case box or above the entrance door. Complete with elegant plastic end caps.



### LED GARAGE LIGHT

Internal LED light for storage compartments and garage facilities. Similar characteristics as LED Awning Light but complete with switch.



### LED WARNING SOLAR

System of two intermittent signal lights. Ideal to be positioned around your motorhome and caravan to highlight a dangerous area. Each light is provided with a solar panel that recharges the internal batteries during the day. The internal rechargeable batteries are capable of being recharged around 500 times.



### LED SENSOR DOOR LIGHT

With PIR and light sensor, it only lights up at night when a person approaches your vehicle; the lights remains on for 60 seconds.

Designed to be installed above the doors of motorhomes and caravans.



### LED AWNING LIGHT GUTTER

External door light, equipped with terminals shaped as a channel, ideal to solve the annoying problem of rain dripping from above the door.



### LED STEP

To increase the safety and visibility of the steps and step wells at the entrance of the motorhome. Made from sturdy anodized aluminium.

Kit is 50cm long but can be shortened to 23cm. The aluminium L profile can be easily attached to the edge of the step.

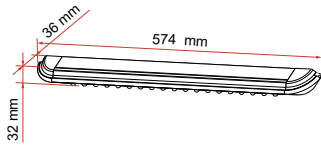
 CHOOSE THE MODEL THAT SUITS YOU

LED Awning Light

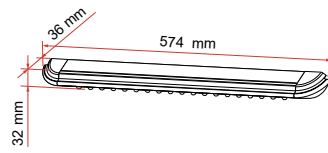

LED Garage Light

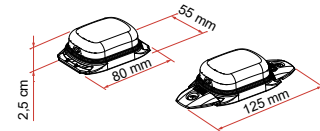

LED Warning Solar

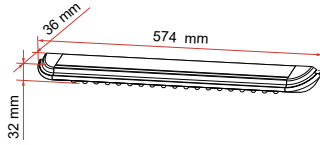

LED Sensor Door Light

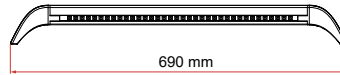

LED Awning Light Gutter

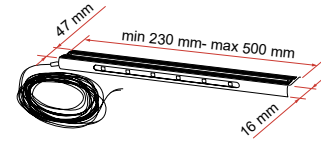

LED Step

	LED Awning Light	LED Garage Light	LED Warning Solar	LED Sensor Door Light	LED Awning Light Gutter	LED Step
Item No.	98655-848	98655-883	98655-885	98655A884	98655-607	98655-886
LED Colour	Cold white	Cold white	Intermit. red	Cold white	Cold white	Cold white
Tone	6500° k	6500° k	-	6500° k	6500° k	6500° k
Light Cone Angle	120°	120°	120°	120°	120°	120°
Lumen	547	547	-	547	547	145
N° LED	31	31	6	31	31	6
Feeding tension	12V	12V	2,4V	12V	12V	12V
Absorbed power	7,4W	7,4W	-	7,4W	7,4W	1,7W
Electric input	0,62A	0,62A	-	0,62A	0,62A	0,14A
IP degree of protection	IP 54	IP 54	IP 54	IP 54	IP 54	IP 54
Weight	0,4kg	0,4kg	0,17kg	0,5kg	0,7kg	0,2kg



LED Awning Light Gutter

# Water pumps

SUITABLE FOR MOTORHOMES, CARAVANS, VAN CONVERSIONS AND CAMPERVANS



- DM 174/2004
- EU 10/2011
- DM 21/03/1973



New 7, 10 and 13 litre Aqua 8F pumps are safe and reliable, ensuring a constant flow and high flow rate in your vehicle.

## FEATURES:

- Equipped with adjustable pressure switch (with the exception of the 13L model)
- 12V power supply and 4 chambers for high flow of water
- Reduced dimensions, filter to be installed in the most convenient position according to the space available
- KTW approved like all Fiamma products that involve contact with water
- Standard stainless steel filter removable for easy cleaning

## MODELS



Aqua 8F 7L -10L



Aqua 8F 13L



## AQUA 8F <sup>new</sup> 20 25

Designed for a constant, high flow rate. Installs in any position, can run dry without damage. Equipped with an internal diaphragm made in a single piece to ensure its watertight seal. 4 chambers for high flow of water. Standard filter. Available in 7, 10 and 13 litres versions.

## A20

The A20 expansion tank eliminates pulsating pump operation and provides a constant flow of water in the required quantity, reducing consumption. The internal diaphragm absorbs water hammer and delivers a regular flow at the outlet. New black finish to give visual continuity to the pump and accessory range, of which it is the perfect complement. Suitable for: all Fiamma pumps and other brands

## CHOOSE THE MODEL THAT SUITS YOU

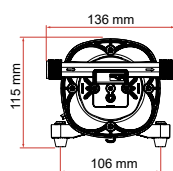

Aqua 8F (7 & 10 litres)

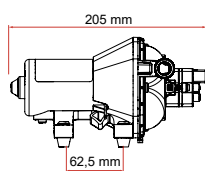

Aqua 8F (13 litres)

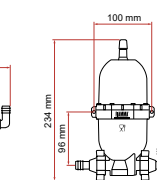
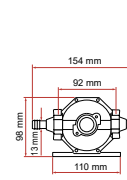
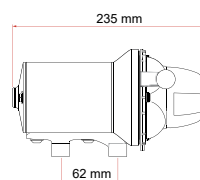
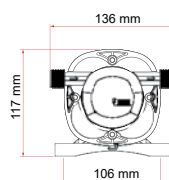

A20

	Item No.	Weight	Power Supply	Max flow l/min. at 0 bar	Noise level	Pressure switch interv.	Section head
Aqua 8F 12V 7L <b>[New]</b>	07073B02-	1,3kg	1,4A	7l / min	50db	1,5Bar	< 5m
Aqua 8F 12V 10L <b>[New]</b>	07073A02-	1,3kg	3A	10l / min	55db	1,8Bar	< 5m
Aqua 8F 12V 13L <b>[New]</b>	07073-02-	2,2kg	2,4A	13l / min	50db	2,2Bar	< 5m
A20	02478-02-	0,3kg	-	-	-	-	-





WATER

FIAMMASTORE

CARRY-BIKE

COMFORT



# Tanks

SUITABLE FOR MOTORHOMES, CARAVANS, VAN CONVERSIONS AND CAMPERVANS



Water is a precious resource that you need to take care of. Both blue tanks, made of food grade material, and the waste water grey tanks are easy to fill, transport and empty. Choose them according to function and capacity.

## FEATURES:

- Watertight cap
- Easy to transport
- Fresh water tanks in new dark blue colour and KTW certified

## FRESH WATER MODELS



### ROLL-TANK 23F

Convenient portable water tank with easy access discharge cap. Compact size (fits through normal vehicle doors). Complete with extra cap for immersion pump (not included).



### ROLL-TANK 40F

Portable water tank, easy grip handle and silent rubber wheels make transportation easy even on gravel. Easy cleaning wide filler cap. The equipment consisting of bayonet cap and hose connector, used for direct filling of the tank, is available as an optional accessory.



### TANK 70

Large water tank, it can be installed vertically or horizontally, it is complete with all the fittings.

## HOMOLOGATIONS

- DM 174/2004
- EU 10/2011
- DM 21/03/1973

Roll-Tank 23F / Roll-Tank 40F / Tank 70

## WASTE WATER MODELS



### ROLL-TANK 23W

Convenient portable waste water tank with easy access discharge cap. Compact size (fits through normal vehicle doors).



### ROLL-TANK 40W

Waste water tank, includes a vent valve and level indicator. Connects to the valve of the motorhome tank via the drain tube. The 45° angle adapter for drain is included.



### KIT SANITARY FLEX

Flexible and extendable up to 300cm, the hose is complete with 2 connections and clamps for connection to the Roll-Tank 40 W and Quick Connection W.



### QUICK CONNECTION W

The adapter to turn the threaded connection into a bayonet connection so that the Sanitary Flex can be easily coupled to the Tank 23 W.



### CAP

Thanks to the key, the cap can be locked and opened for greater security. Available white and black.

## CHOOSE THE MODEL THAT SUITS YOU

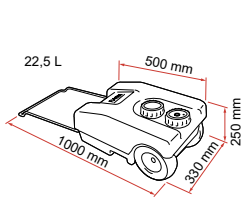

Roll-Tank 23 F

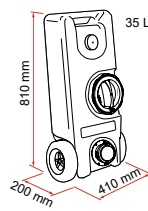

Roll-Tank 40 F

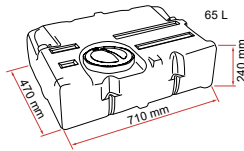

Tank 70

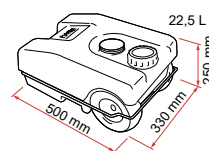

Roll-Tank 23 W

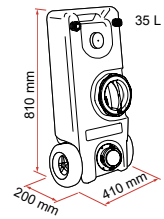

Roll-Tank 40 W

	Roll-Tank 23 F <b>[Restyling]</b>	Roll-Tank 40 F <b>[Restyling]</b>	Tank 70 <b>[Restyling]</b>	Roll-Tank 23 W	Roll-Tank 40 W
Item No.	02428A03A	08307-03A	08306-03-	02428A01-	08307-01-
Weight	2,4kg	3,8kg	4,4kg	2,4kg	3,9kg
Capacity	22,5L	35L	65L	22,5L	35L
	Kit Sanitary Flex	Quick Connection W	Cap White	Cap Black	
Item No.	02438A01-	06497-01-	94715-010	94715-005	
Weight	0,8kg	0,2kg	0,2kg	0,2kg	

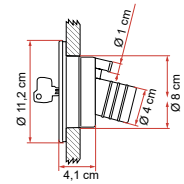

Cap







# Levelling systems

SUITABLE FOR MOTORHOMES, CARAVANS, VAN CONVERSIONS, CAMPERVANS AND 4x4



The ground on which you park your vehicle is not always perfectly level. That's why we suggest you purchase one of our levelling systems, designed to stabilise each type of vehicle.

## FEATURES:

- Protects the tyre
- Does not sink into the ground
- Equipped with levelling cradles
- Easy to transport and lightweight
- Resistant
- Pack of 2 pieces

## MODELS



### KIT LEVEL UP PREMIUM

With three levelling cradles, handle for a safe and easy positioning of the product under the vehicle and high manoeuvrability. Delivered as standard with Level Bag Premium. Ideal for motorhomes.



### KIT LEVEL UP PREMIUM S

Ideal for motorhomes and van conversions. Same features as the Level Up Premium Kit, but with reduced size and weight. The practical Level Bag is included as standard.



### LEVEL UP - KIT LEVEL UP

Ideal for motorhomes, van conversions, campervans and 4x4. Ridged surface to grip to the vehicle's tyres. Consists of three levels, lightweight and easy to clean. The Kit version is complete with Level Bag.



### LEVEL PRO

Ideal for caravans and camper vans. Practical self-locking overlapping interlocking levelling system to raise height. Ridged surface to grip to the vehicle's tyres.



### LEVEL SYSTEM MAGNUM

Ideal for larger motorhomes. Practical self-locking overlapping interlocking levelling system to raise height.



### LEVEL SYSTEM JUMBO

Ideal levelling system for larger motorhomes with twin wheels, overlapping.



### CHOOSE THE MODEL THAT SUITS YOU

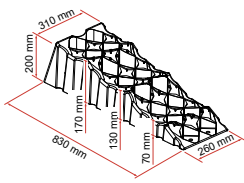

Level Up Premium

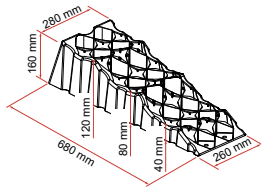

Level Up Premium S

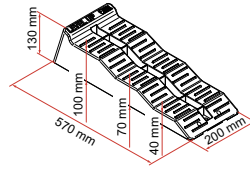

Level Up

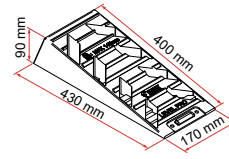

Level Pro

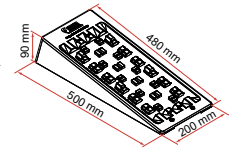

Level System Magnum

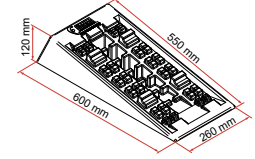

Level System Jumbo

	Kit Level Up Premium*	Kit Level Up Premium S*	Level Up	Kit Level Up	Level Pro	Level System Magnum	Level System Jumbo
Item No.	97901-058	97901-062	97901-038	97901-059	97901-011	97901-015	97901-016
Colour	grey	grey	grey	grey	grey	yellow	yellow
Dimensions	83x31x20cm	68x28x16cm	57x20x13cm	57x20x13cm	43x17x9cm	50x20x9cm	60x26x12cm
Levels	3	3	3	3	-	-	-
Max axle weight	5,0t	5,0t	5,0t	5,0t	5,0t	8,0t	12,0t
Overlapping	no	no	no	no	yes	yes	yes
Weight	3,7kg each	2,3kg each	1,45kg each	1,45kg each	0,8kg each	1,3kg each	2,9kg each
Compatible with	Motorhome	Motorhome - Van conversions	Motorhome - SUV Camper vans - Van conversions	Motorhome - SUV Camper vans - Van conversions	Caravan - Camper vans	Motorhome - Caravan - SUV Camper vans - Van conversions	Motorhome
Chock Level	-	-	●	●	●	●	-
Anti Slip Plate	-	-	●	●	●	●	-
Level Bag Premium	●	-	-	-	-	-	-
Level Bag	-	●	●	●	-	-	-
Level Bag S	-	-	-	-	●	●	-
Level Plate	-	-	●	●	-	-	-

\* This item is not offered for sale to UK customers and must not be imported into the UK or sold to third parties in the UK.

● Standard

○ Optional

### ADD TO YOUR LEVELS



#### CHOCK LEVEL

Pair of 2 grey chocks to secure the wheels during long stopovers.



#### ANTI SLIP PLATE

Optional anti-slip plate for paved surfaces.



#### LEVEL PLATE

Anti-skid system, installed under the Fiamma Level Up to increase its traction, avoiding skidding on smooth surfaces and sinking into soft grounds.



#### LEVEL BAG / LEVEL BAG S

Bag in washable polyester, for storing levels after use.

	Chock Level	Anti Slip Plate	Level Plate	Level Bag	Level Bag S
Item No.	97901-037	97901-012	97901-041	05950A02B	05950B02B
Colour	grey	grey	grey	black, grey, red	black, grey, red
Weight	0,1kg	0,1kg	0,3kg	0,2kg	0,2kg
Compatible with	Level Up (Kit) - Level Pro - Level System Magnum	Level Up (Kit) - Level Pro - Level System Magnum - Wheel Saver	Level Up (Kit)	Level Up (Kit)	Level Pro - Level System Magnum - Wheel Saver

# Levelling systems

SUITABLE FOR MOTORHOMES, CARAVANS, VAN CONVERSIONS, CAMPERVANS AND 4x4



Provides safety and stability for your vehicle.

## FEATURES:

- Resistant material, UV-resistant
- Easy to transport and lightweight

Wheel & Grip

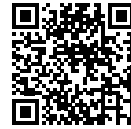

Jacks



Anti-sinking bases



## MODELS



### GRIP SYSTEM

Anti-skid system with superior traction, to be placed under the driving wheels of vehicles.

They can be combined in length for a greater traction surface.



### WHEEL SAVER

System of cradles that avoids ovalisation of the tyres, suitable for wheels up to 70cm in diameter. Ideal in case of long parking and storage of motorhomes and caravans.



### ALU JACKS

Polished aluminium jack.

Package of 4 stacked pieces during transport.

Adjustable in height from min. 28cm to max. 43cm.



### PLASTIC JACKS

Plastic jacks. Package of 4 stacked pieces during transport.

Adjustable in height from min. 31cm to max. 44cm.



### PLATES PRO

Kit of four anti-sinking bases supplied with four locks to be fastened to the vehicle's lifting jacks.



### PLATES

Kit of four highly reinforced anti-sinking plates. Also ideal for use with jacks or with the caravan's A-frame leg.

## CHOOSE THE MODEL THAT SUITS YOU

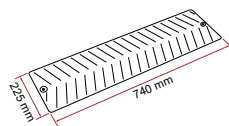

Grip System

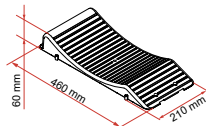

Wheel Saver

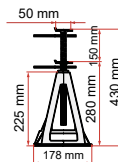

Alu Jacks

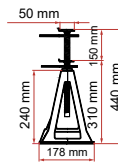

Plastic Jacks

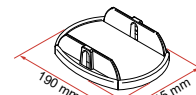

Plates Pro

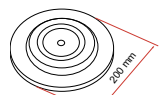

Plates

	Grip System	Wheel Saver		Alu Jacks	Plastic Jacks	Plates Pro	Plates
Item No.	97901-055	97901-013	Item No.	00680-01-	00680C01G	97901-057	97901-056
Colour	grey	grey	Colour	aluminium	grey	grey	grey
Weight	0,4kg each	0,6kg each	Weight	0,9kg each	0,8kg each	0,2kg each	0,2kg each
Compatible with	Reisemobil - Wohnwagen - Campingbus - Kastenwagen - Suv	Reisemobil - Wohnwagen - Kastenwagen	Max axle weight	1000kg each	750kg each	-	-



**+** COMPLETE YOUR VEHICLE WITH



**STEP**

Step for caravans and motorhomes, made of HD polyethylene for more stability and strength. Anti-skid surface.



**STEP MAGNUM**

Stronger and larger step made of polypropylene. Anti-skid surface.



**STEP-MAT**

Covering for the surface of Fiamma Steps. Made of soft and flexible anti-skid rubber.



**CLEAN STEP**

Convenient doormat to be placed on the electric or manual steps of motorhomes and caravans. Also ideal for double steps.



**≡** CHOOSE THE MODEL THAT SUITS YOU

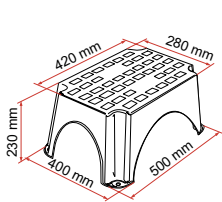

Step

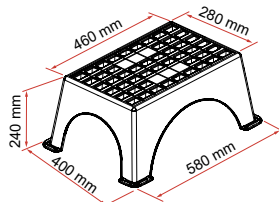

Step Magnum

	Step	Step Magnum	Step-Mat	Step-Mat Magnum	Clean Step Green	Clean Step Black
Item No.	02950-01-	04630-01-	06373-01-	06374-01-	04593-01-	04593-01A
Colour	grey	grey	grey	grey	green	black
Weight	1,0kg	1,3kg	0,4kg	0,5kg	0,2kg	0,2kg
Max axle weight	150kg	200kg				





# Organizer

SUITABLE FOR MOTORHOMES, CARAVANS, VAN CONVERSIONS, CAMPERVANS AND 4x4



When travelling, like at home, it is important that everything is in order and in its place. For this reason Fiamma created the Organizer range, to enable you to neatly organise the space both inside and outside of the vehicle.

## FEATURES:

- Many models
- Easy to install
- Can be installed in 3 different ways: on rail, using eyelets, with Fix Organizer

## MODELS



### PACK ORGANIZER BOX

Spacious organiser box, occupies minimum space when closed.  
Dimensions: 60x36x31cm.



### FIX ORGANIZER

Practical fixing system.  
Dimensions: 5.5x3x1cm.



### PACK ORGANIZER MIX

Practical multi-purpose polyester organiser bin with zip fastener and pop-up opening for minimum space when closed. Its shape and simplicity make it suitable for storing a wide range of objects such as toys or laundry. The 4 bag clamps, supplied as standard, also allow it to be used as a dustbin.  
Diameter 28cm, height 40cm.



### MEGA BAG ELITE / SMART L

Storage bag for panels and Privacy Room.  
**Mega Bag Elite**

Dimensions: 150x35x35cm.  
Equipped with wheels, internal net pockets with elastic border and reinforcement panel on the bottom and 2 on the sides.

#### **Mega Bag Smart L**

Dimensions: 195x25x25cm.  
Length increased, to hold and carry skis too with internal Velcro fasteners to secure skis and studded holes to allow small amounts of water to escape; with internal pockets.



### MEGA BAG / MEGA BAG LIGHT

New version, proposed alternative to the current bags supplied with Fiamma Privacy Rooms. Useful for storing panels and Privacy Rooms.

**Mega Bag:** 140x27x40cm

**Mega Bag Light:** 140x25x25cm



### CARRY-DOG

Folding dog house, complete with bag and handle for easy transportation, carpet and eyelets to fasten it to the ground. Side windows are with mosquito net which can be rolled up with Velcro. Dimensions: 75x55x49cm.



### PACK ORGANIZER TOILETRY

Container for bathroom fittings.

Dimensions: 30x37x11cm.

Number of pockets: 10.

 MODELS
**PACK ORGANIZER L**

For little objects.  
Dimensions: 88x39cm.  
Number of pockets: 6.

**PACK ORGANIZER S**

For little objects.  
Dimensions: 50x84cm.  
Number of pockets: 11.

**PACK ORGANIZER SEAT**

To hang up on the rear part of the seats of your vehicle.  
Dimensions: 43x66x4cm.  
Number of pockets: 4.

**PACK ORGANIZER SHOES**

Container for shoes.  
Dimensions: 84x54x18cm.  
Number of pockets: 10.

**PACK ORGANIZER PRIVACY**

Optimise the space inside your enclosure and keep everything within reach, thanks to these storage containers that attach directly to the panels.

 CHOOSE THE MODEL THAT SUITS YOU

	Weight	Dimensions	Number of pockets	Triple Fixing*	Function	Item No.
Pack Organizer Box	2,8kg	60x36x31cm	-	-	-	08207-01-
Pack Organizer Mix	0,3kg	ø 28cm - h 40cm	-	-	-	08725-01-
Mega Bag Elite	4,2kg	150x35x35cm	-	-	-	08373-01-
Mega Bag Smart L	1,6kg	195x25x25cm	-	-	-	08374A01-
Mega Bag	1,1kg	140x27x40cm	-	-	-	08843-01-
Mega Bag Light	0,6kg	140x25x25cm	-	-	-	08844-01-
Carry-Dog	2,8kg	75x55x49cm	-	-	-	08201-01-
Pack Organizer Toiletry	0,6kg	30x37x11cm / 30x118x11cm	10	-	Container for bathroom fittings	07515-01-
Fix Organizer	0,1kg	5,5x3x1cm	-	-	-	98655-163
Pack Organizer L	0,5kg	88x39cm	6	●	For little objects	07512A01-
Pack Organizer S	0,4kg	50x84cm	11	●	For little objects	07512-01-
Pack Organizer Seat	0,3kg	43x66x4cm	4	-	To hang up on the rear part of the seats of your vehicle	07514-01-
Pack Organizer Shoes	1,1kg	84x54x18cm	10	●	Container for shoes	07513-01-
Pack Organizer Privacy	0,4kg	115x30cm	4	-	For little objects	07366-01-

\* 3 installation modes: on rail, using eyelets (screws not included), with Fix Organizer (optional)





# Pocket

SUITABLE FOR MOTORHOMES, CARAVANS, VAN CONVERSIONS, CAMPERVANS AND 4x4



Multipurpose pockets to organize your space in the best possible way and always have everything in order.

## FEATURES:

- Different dimensions available
- Easy to install with the provided screws

## MODELS



**POCKET PLUS M**



**POCKET PLUS L**



**POCKET M**



**POCKET L**



**POCKET XL**

## CHOOSE THE MODEL THAT SUITS YOU

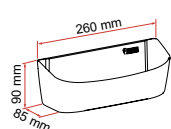

Pocket Plus M

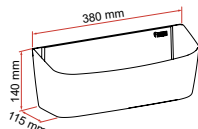

Pocket Plus L

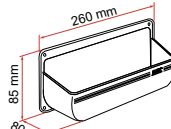

Pocket M

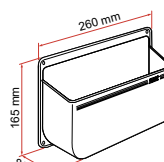

Pocket L

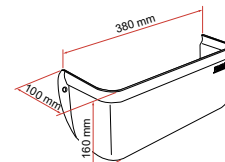

Pocket XL

	Weight	Colour	Dimensions	Item No.		Weight	Colour	Dimensions	Item No.
Pocket Plus M	0,1kg	grey	26x8,5x9cm	08309-01-	Pocket M	0,1kg	white	26x8,5x8cm	03177-01-
Pocket Plus L	0,4kg	grey	38x11,5x14cm	08308-01-	Pocket L	0,1kg	white	26x16,5x8cm	03178-01-
					Pocket XL	0,3kg	grey	38x16x10cm	03284-01-





# Ultra-Box

SUITABLE FOR MOTORHOMES



You can never have enough luggage when you go on holiday. Choose one of our spacious roof boxes for your motorhome.

## FEATURES:

- Material: ABS
- Reinforced aluminium structure
- Watertight foam seal
- Complete with installation brackets and stainless steel hinges



**ULTRA-BOX 2**



**ULTRA-BOX 3**

## CHOOSE THE MODEL THAT SUITS YOU

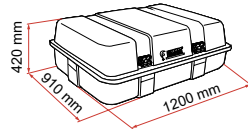

Ultra-Box 2

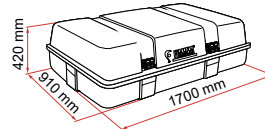

Ultra-Box 3

	Volume	External dimensions	Internal dimensions	Weight	Item No.
Ultra-Box 2	400l	120x91x42cm	107,5x77,5x37,5cm	13kg	02084-01-
Ultra-Box 3	520l	170x91x42cm	155x77,5x37,5cm	17kg	02085-01-





# Roof Rail Ducato

SUITABLE FOR VAN CONVERSIONS



To make the most of your vehicle's roof, a complete roof rack system for Fiat Ducato, Citroën Jumper and Peugeot Boxer.

## FEATURES:

- Installation without drilling the vehicle
- Max. load capacity: 150kg
- Two finishes: aluminium and Deep-Black
- Roof Rail Ducato: can be installed on Ducato vehicles with H2 high roof, L1, L2 and L3 lengths Roof Rail
- Ducato Maxi XL: for vehicles with H2 high roof and L4 length
- Roof rail Ducato H3: version for Ducato with H3 high roof and L3 and L4 length



**01** Brackets F80s / F65s  
Supplied as standard.  
To mount the awning without  
drilling the vehicle

**02** F80s  
Roof awning  
(to be purchased separately).  
It is ideal to combine with  
Ducato Roof Rail

**03** Kit Roof Rail Ducato Cover Left  
Optional accessory kit to cover the  
mounting brackets (3 pcs)

**04** Kit Roof Rail Ducato Cover Right  
Optional accessory kit to cover the  
mounting brackets (3 pcs)

**05** Roller Roof Rail  
Add it to the Roof Rail  
It will be a convenient aid in  
loading and unloading operations

**06** Kit Roof Rail Ducato Extra  
Pair of additional brackets for  
Ducato Maxi XL Roof Rail





### CHOOSE THE MODEL THAT SUITS YOU

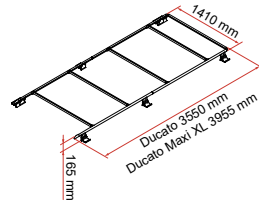

Roof Rail Ducato

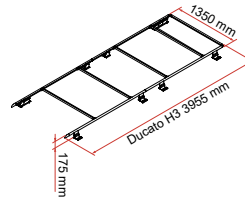

Roof Rail Ducato H3

	Roof Rail Ducato * (h 16,5cm)	Roof Rail Ducato * Deep Black (h 16,5cm)	Roof Rail Ducato Maxi XL **	Roof Rail Ducato H3 ***	Roof Rail Ducato H3 - RHD ***
Item No.	05808-01-	05808A01A	05808-02-	05808-03-	05808-04-
Weight	12,0kg	12,0kg	13,5kg	14,2kg	14,2kg

### ACCESSORIES

	Kit Roof Rail Ducato Extra 16,5cm ****	Kit Roof Rail Ducato Extra 14,5cm ****	Kit Roof Rail Ducato Extra Cover	Kit Roof Rail Ducato Cover Left	Kit Roof Rail Ducato Cover Right	Roller Roof Rail
Item No.	98658-066	98658-097	98658-103	98658-101	98658-102	06876-01-
Bracket H	16,5cm	14,5cm	-	-	-	-
Weight	1,0kg	1,0kg	0,1kg	0,1kg	0,1kg	1,5kg

Kit Roof Rail Ducato Extra Cover / Cover Left / Cover Right suitable with brackets h 16.5cm.

\* can be installed on Ducato vehicles with H2 high roof, L1, L2 and L3 lengths (to reach the desired length you can cut the 2 lateral bars, which are delivered as standard in L3 version)

\*\* for vehicles with H2 high roof and L4 length

\*\*\* version for Ducato with H3 high roof and L3 and L4 length. Delivered as standard with 4 Fixing-Bar Rail

\*\*\*\* Additional set of 2 brackets (to use with Roof Rail Ducato Maxi XL)





# Fixing-Bar

SUITABLE FOR MOTORHOMES, CARAVANS AND VAN CONVERSIONS



Carry what you want on the roof of your motorhome, caravan or van conversion with this range of accessories designed to organise it in the best possible way.

## FEATURES:

- Adaptable to different types of vehicles
- Easy to install

## MODELS



### ROOF RAIL

Two longitudinal bars that can be shortened, easy to install on the roofs of motorhomes and caravans. The anodised aluminium tubes are suitable for quick attachment of the optional Fixing-Bar Rail.



### FIXING-BAR RAIL

Roof rails in anodised aluminium. Easily combinable with the Roof Rail without drilling the vehicle, easily shortened. Delivered as standard with:

- 2x bars
- 4x fixing terminals in aluminium pressure die-casting
- 4x rubber spacers



### FIXING-BAR PRO L

Roof rail in extruded aluminium, easily to shorten. To be placed on the camper or caravan roof. Ideal supporting system for solar panels or roof boxes. Delivered as standard with:

- 1x bar
- 2x white end caps (PA)
- 1x rubber spacer

## CHOOSE THE MODEL THAT SUITS YOU

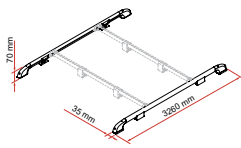

Roof Rail

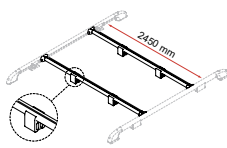

Fixing-Bar Rail

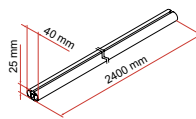

Fixing-Bar Pro L

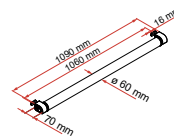

Roller Roof Rail

	Roof Rail	Fixing-Bar Rail	Fixing-Bar Pro L	Roller Roof Rail
Item No.	05516-01-	98655-075	98655-295	06876-01-
Weight	4,7kg	3,4kg	1,5kg	1,5kg



### ROLLER ROOF RAIL

Roller for loading the roof rack. Facilitates the loading and unloading of canoes, kayaks and other objects from the rear of the vehicle. Ideal to be used with Roof Rail Ducato, Roof Rail Ducato Maxi XL.

# Garage

SUITABLE FOR MOTORHOMES



How to best organise the inside of your garage? With our practical shelving and multi-purpose bars.

## FEATURES:

- Suitable for all models of motorhomes
- Made of light and strong aluminium 6060

## MODELS



### GARAGE SYSTEM STANDARD

Single stand with three shelves to position the optional folding boxes or to put all the goods of the camper away tidily in the camper storage compartment.

Adjustable in height and with section bars that can be shortened in case of rear steps or narrow, curved spaces.



### GARAGE SYSTEM UPGRADE

To enlarge the standard module with a second shelf. It can be used with the Garage System Standard.

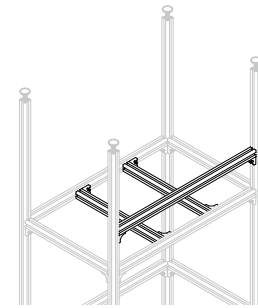

### GARAGE SYSTEM SUPPORT

Set of two lower bars and one side aluminium bar to be used as a support for the Garage System, for greater support of the transported load.



### GARAGE BOX

Set of three folding boxes suitable for the shelves of the Garage System; folded down they take up little space.



### GARAGE WALL BRACKETS KIT

Optional kit for wall installation or installation on the side bars Garage-Bars for garage with adjustable roof height.



### GARAGE BARS

Multipurpose aluminium bars to be applied to garage walls or floors. Four versions available:

- Garage Bars
- Garage Bars Corner
- Garage Bars Premium 200
- Garage Bars Premium 60



MODELS



**LUGGAGE BAR**

Telescopic bar ideal for easily and safely fastening your objects into the storage compartments or dinette of the vehicle while travelling. Easy to regulate using the handy hook lever. Easy to shorten (minimum length of 93cm) and extends up to 170cm.



**GARAGE CARRY-RAIL**

The clothes rack is composed of a sturdy light tubular bar in anodized aluminium, supported by two strong ceiling fixings. Please verify the solidity of the ceiling before applying the product. Ideal for hanging clothes and various items. Load capacity: 10kg.

CHOOSE THE PRODUCT THAT SUITS YOU

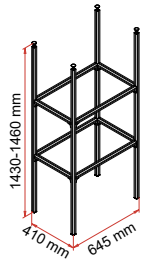

Garage System Standard

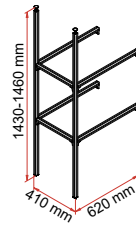

Garage System Upgrade

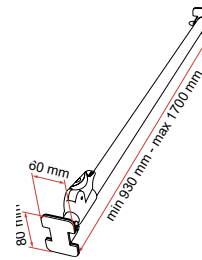

Luggage Bar

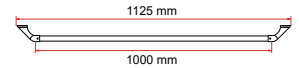

Garage Carry-Rail

	Garage System Standard	Garage System Upgrade	Garage System Support	Garage Box (3 pcs.)	Kit Garage Wall Brackets	Luggage Bar	Garage Carry-Rail
Item No.	98655-907	98655-908	98656-772	98655-909	06667-01-	05411-03-	06112-01-
Weight	5,7kg	3,9kg	0,9kg	5,6kg	0,1kg	0,7kg	0,5kg
Lenght	-	-	-	-	-	min 93cm - max 170cm	112,5cm

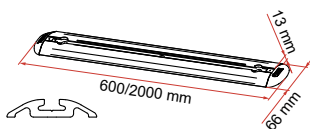

Garage Bars Premium

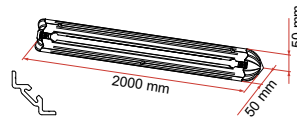

Garage Bars Corner

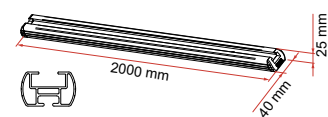

Garage Bars

	Garage Bars Premium 200 (2 pcs.)	Garage Bars Premium 60 (2 pcs.)	Garage Bars Corner (2 pcs.)	Garage Bars (2 pcs.)
Item No.	98655-609	98655-608	98655-906	98655-480
Weight	4,8kg	2,2kg	4,8kg	3,1kg
Kit Eye Premium/Corner*	●	●	●	-
Kit Eye*	-	-	-	●

● Standard

\* can be purchased separately in case you want more sliding hooks

## + ACCESSORIES



### EYE PREMIUM/CORNER KIT

Additional hooks for Garage Bars Premium/Corner.



### EYE KIT

Additional hooks for Garage Bars.

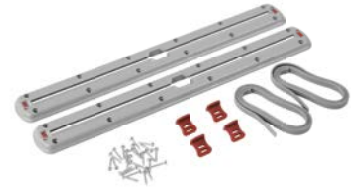

### CARGO STRAP

To block objects such as small tables, chairs, spare wheels in the storage compartment or in the garage of your motorhome. Length of elastic bands 100cm.



### CARGO ACCESSORY KIT

Optional kit in combination with Cargo Strap.



### KIT SQUARE PLATES

Corrosion-proof stainless steel hooks for easier load securing. To be applied to the garage floor or walls.

## - CHOOSE THE PRODUCT THAT SUITS YOU

	Kit Eye Premium/ Corner (2 pcs.)	Kit Eye (2 pcs.)	Kit Square Plates (4 pcs.)	Cargo Strap	Kit Cargo Accessory
Item No.	98656-735	98656-494	98656-485	05677-01-	98656-510
Weight	0,1kg	0,1kg	0,1kg	0,5kg	0,1kg



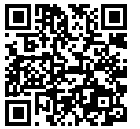

# Safe Door

SUITABLE FOR MOTORHOME, CARAVANS AND VAN CONVERSIONS



A wide range of safety locks for peace of mind while you are on holiday.

## FEATURES:

- Suitable for motorhome and caravans (Safe Door Guardian for van conversions)
- Easy to install
- 3 colours available for Safe Door and Safe Door Frame: white, grey and black
- Safe Door Magnum and Safe Door Magnum Frame available in white
- To increase the security of storage compartments and garage doors

## MODELS



### SAFE DOOR

Made of sturdy painted aluminium, without plastic parts. Wall fixing with 4 through screws.



### SAFE DOOR FRAME

Made of sturdy painted aluminium, without plastic parts. Ideal for installation on the internal profiles of motorhome and caravan doors with 3 self-threading screws.



### SAFE DOOR MAGNUM

Length extended to 20cm in order to cover, where possible, the locks of the motorhome doors.



### SAFE DOOR MAGNUM FRAME

Fixing on the internal profiles of the doors with 3 self-threading screws and length extended to 20cm to cover, where possible, the locks of the doors.



### SAFE DOOR GUARDIAN

Made of sturdy aluminium, without plastic parts. It is installed in place of the standard weak plastic blocks in the living unit, in the same position and using the same fixing holes. Versions for Ducato and Transit are available as well.



### DUO SAFE PRO

Security system to keep the vehicle cabin doors closed from the inside.

Tested on:

- Fiat Ducato, Citroën Jumper, Peugeot Boxer and Renault Master ≤ 2006
- Mercedes Sprinter, Fiat Ducato, Renault Master, Ford Transit ≥ 2006
- Also suitable for Iveco Daily's cabin

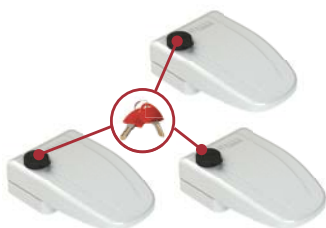

\* One Key System  
Version "3" works with the One Key System: it is composed of three pieces of Safe Door or Safe Door Frame with locks using the same key.



### CHOOSE THE MODEL THAT SUITS YOU

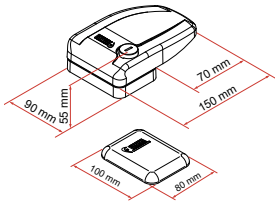

Safe Door

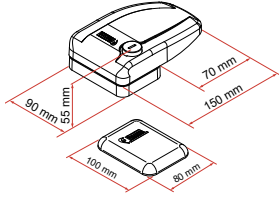

Safe Door 3

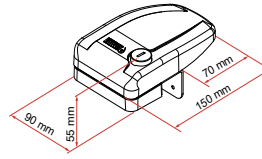

Safe Door Frame

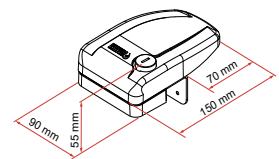

Safe Door Frame 3

	One Key System	Door side frame	Weight	Colour	Item No.
Safe Door	-	-	0,6kg	white / grey / black	08021-01- / 08021-01G / 08021-01A
Safe Door 3	●	-	1,7kg	white / grey / black	08021-02- / 08021-02G / 08021-02A
Safe Door Frame	-	●	0,5kg	white / grey / black	08022-01- / 08022-01G / 08022-01A
Safe Door Frame 3	●	●	1,5kg	white / grey / black	08022-02- / 08022-02G / 08022-02A

● Standard

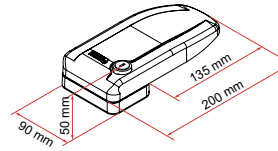

Safe Door Magnum

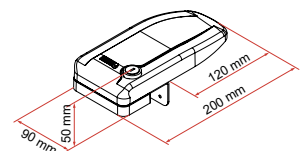

Safe Door Magnum Frame

	Door side frame	Weight	Colour	Item No.
Safe Door Magnum	-	0,6kg	white	08277-01-
Safe Door Magnum Frame	●	0,6kg	white	08277A01-

● Standard

### CHOOSE THE MODEL THAT SUITS YOU

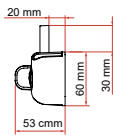

Safe Door Guardian

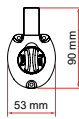

Safe Door Guardian Ducato &gt; 2009

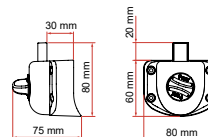
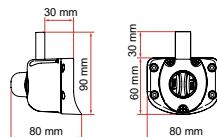

Safe Door Guardian Ducato &gt; 2006 &lt; 2009

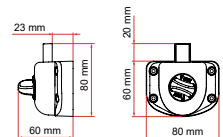

Safe Door Guardian Transit &lt; 2006

	Item No.	Weight
Safe Door Guardian	05388-01-	0,3kg
Safe Door Guardian Ducato > 2009	05388-07-	0,4kg
Safe Door Guardian Ducato > 2006 < 2009	05388-04-	0,4kg
Safe Door Guardian Transit < 2006	05388-03-	0,4kg
Safe Door Guardian Transit > 2006 < 2014	05388-05-	0,4kg
Duo-Safe Pro	05411-02-	1,0kg

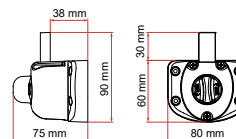

Safe Door Guardian Transit &gt; 2006 &lt; 2014

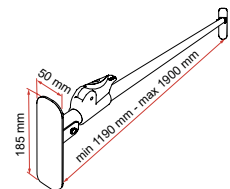

Duo-Safe Pro

### ACCESSORIES

#### SPACER SAFE DOOR KIT >2017

Kit of spacers to reduce the space between Safe Door lock and wall, to adapt it to the shape of the Safe Door family. Available in colours: white, grey and black.

	Weight	Item No. - White	Item No. - Grey	Item No. - Black
Kit Spacer Safe Door > 2017	0,1kg	08230-01-	08230-01G	08230-01A

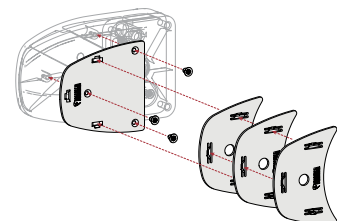



# Security

SUITABLE FOR MOTORHOMES AND CARAVANS



Security handles made of 6060 aluminium, to help you get in and out of the vehicle.

## FEATURES:

- Foldable against the wall
- Suitable for both right and left opening of doors
- Equipped with non-slip grip
- Increase security by discouraging break-ins
- Deep Black finish version available (Security 31 and 46)

## MODELS



### SECURITY 31

Security handle made of painted aluminium, Ø 30mm and thickness 2mm. Height 31cm.

### SECURITY 46

Security handle made of painted aluminium, Ø 30mm and thickness 2mm. Height 46cm.

### SECURITY S

M-shaped security handle with less projection, made of painted aluminium, Ø 30mm and 2mm thickness. Height 46cm.



### SECURITY 46 PRO

Security handle made of painted aluminium, Ø 30mm and thickness 2mm. Height 46cm. Complete with Security Lock Kit for greater security and solidity thanks to the third fixing point on the door.

## ACCESSORIES



### SECURITY GRIP

Non-slip neoprene cover to protect the Security handles security grip.



### KIT SECURITY LOCK

Optional safety lock kit for security 31, 46 and Security S, to be installed on the door of the motorhome. Delivered as standard with keys and internal brackets.

CHOOSE THE MODEL THAT SUITS YOU

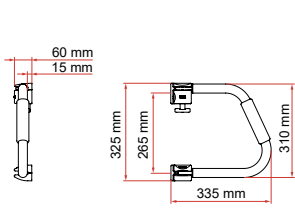

Security 31

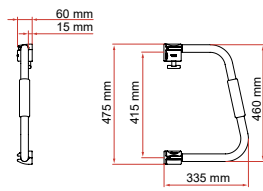

Security 46

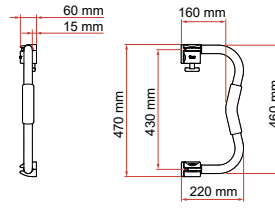

Security S

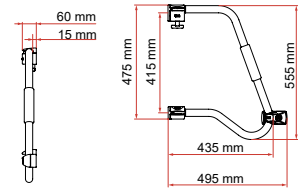

Security 46 Pro

	Item No.	Colour	Weight	Kit Security Lock	Security Grip
Security 31	03513-01-	White	1,1kg	○	●
Security 46	03513A01-		1,2kg	○	●
Security 31 Deep Black <b>[New]</b>	03513-01H	Deep Black	1,1kg	○	●
Security 46 Deep Black <b>[New]</b>	03513A01H		1,2kg	○	●
Security S	03513-05-		1,1kg	○	●
Security 46 Pro	03513-04-	White	1,7kg	●	●
Kit Security Lock	98656-433		0,5kg	-	-
Security Grip	07093-01-	Black	0,4kg	-	-

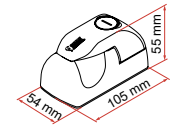

Security Grip

● Standard    ○ Optional







# Deluxe

SUITABLE FOR MOTORHOMES AND CARAVANS



Interior and exterior ladders, different models to adapt to your vehicle.

## FEATURES:

- Tubes  $\varnothing$  30mm and thickness 2mm
- Anodised or painted aluminium
- Non-skid finish
- Step inner width: 28cm
- Step total width: 35cm

## MODELS

### DELUXE 4B



Equipped with 15° inclined steps for the inside of the overcab motorhome or for caravans with sleeping berths. Height: 150cm.

### DELUXE 5B



Equipped with 15° inclined steps for the inside of the overcab motorhome or for caravans with sleeping berths. Height: 165cm.

### DELUXE 8



Ladder with 8 steps and fold up structure. Ideal for the rear wall of the motorhome. Black plastics, with signal step with red plastics.

### DELUXE 5D



Ladder with 10 steps and fold up structure. Ideal for the rear wall of the motorhome. Black plastics, with signal step with red plastics.

### SAFE LADDER



Reinforced safety plate. Suitable for single fixed ladders or folding ladders. Complete with knob and key.

CHOOSE THE MODEL THAT SUITS YOU

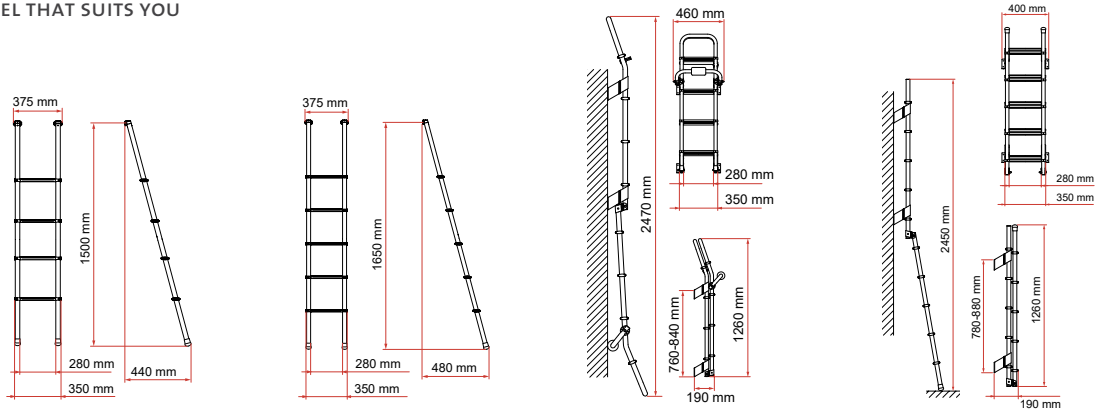

Deluxe 4B

Deluxe 5B

Deluxe 8

Deluxe 5D

	Deluxe 4B	Deluxe 5B	Deluxe 8	Deluxe 5D	Safe Ladder
Item No.	02426-12-	02426-13-	02426-02A	02426-08A	98656-480
Weight	2,4kg	2,6kg	5,5kg	4,9kg	1,3kg
Colour	Aluminium	Aluminium	Aluminium	Aluminium	Aluminium
Number of steps	4	5	8	10	-
Folding	-	-	•	•	-

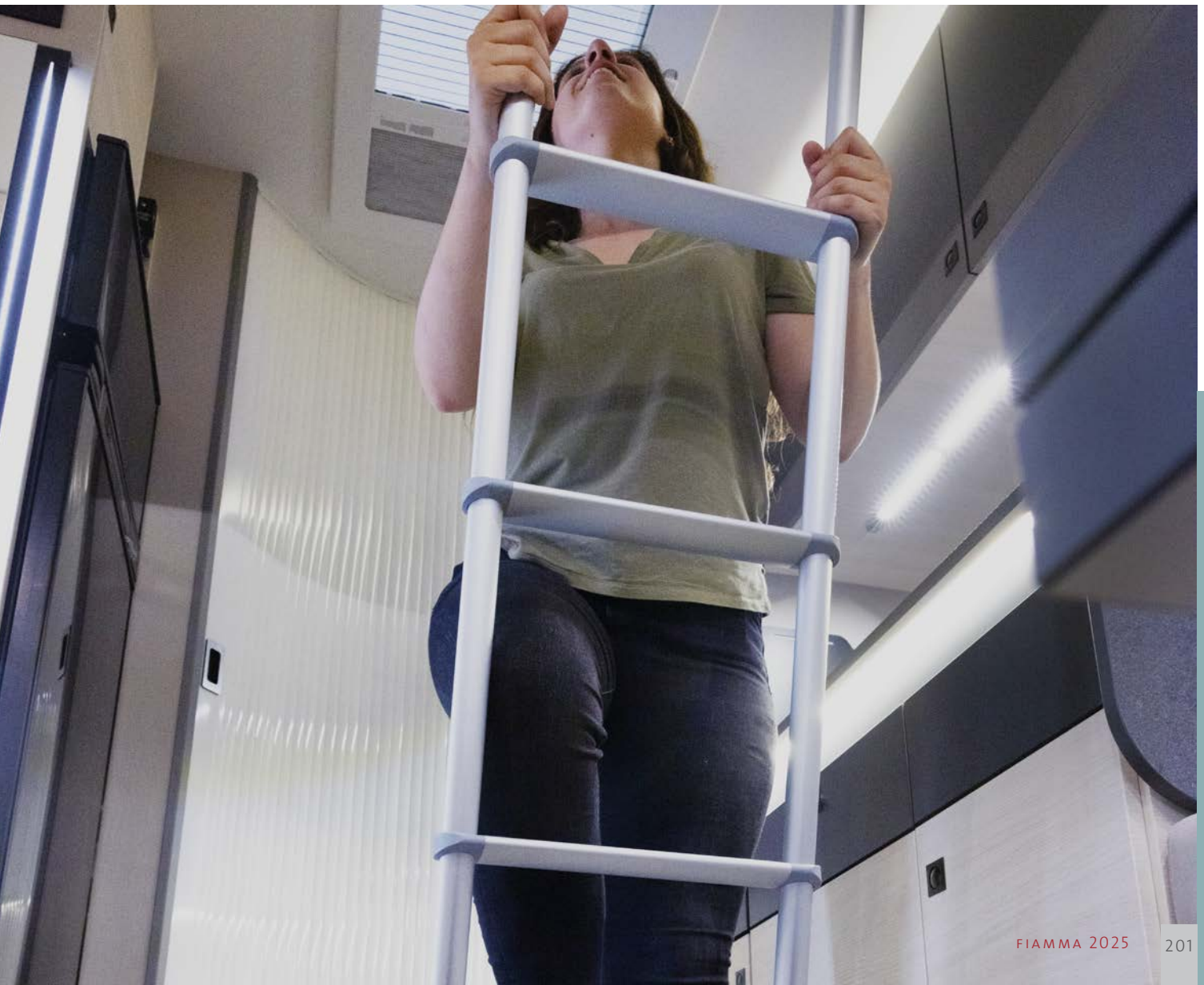



# Deluxe DJ

SUITABLE FOR VAN CONVERSIONS



For the dedicated ladders for Sprinter, Crafter and Transit vehicles.

One structure for all models and dedicated fixing bars for each vehicle type can be purchased separately.

## FEATURES:

- Tubes  $\varnothing$  30mm and thickness 2mm
- Anodised or painted aluminium
- Non-skid finish
- Step inner width: 28cm
- Step total width: 35cm

## COMPOSITION

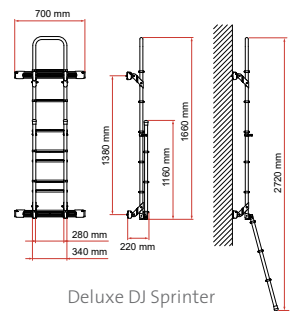

Deluxe DJ Sprinter

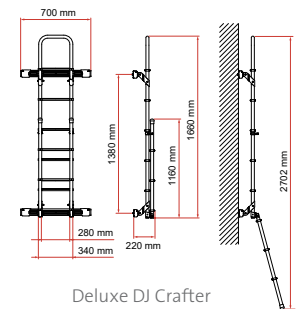

Deluxe DJ Crafter

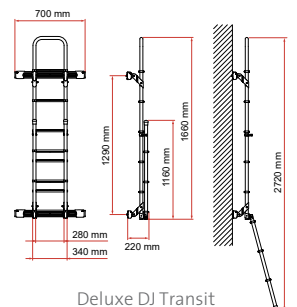

Deluxe DJ Transit

## CHOOSE THE MODEL THAT SUITS YOU

	Kit Bars Deluxe Sprinter $\geq 06$ / Crafter $\geq 06 \leq 16$	Kit Bars Deluxe Crafter $\geq 17$	Kit Bars Deluxe Transit $\geq 14$	Deluxe DJ
Colour	Deep Black / Aluminium	Deep Black / Aluminium	Deep Black / Aluminium	Deep Black / Aluminium
Item No.	08772-03A / 08772-03-	08772-01A / 08772-01-	08772-02A / 08772-02-	02426-22A / 02426-22-
Weight	2,2kg	2,1kg	2,0kg	5,5kg
Number of steps	-	-	-	8
Folding	-	-	-	●
Compatible with	Carry-Bike Frame Sprinter / Carry-Bike DJ Sprinter	Carry-Bike Frame Crafter / Carry-Bike DJ Crafter	Carry-Bike DJ Transit	-





# Deluxe DJ Ducato

SUITABLE FOR VAN CONVERSIONS



Outdoor ladders specifically for Fiat Ducato, Citroën Jumper, Peugeot Boxer.

## FEATURES:

- Tubes  $\varnothing$  30mm and thickness 2mm
- Anodised or painted aluminium
- Non-skid finish
- Step inner width: 28cm
- Step total width: 35cm

## MODELS



### DELUXE DJ DUCATO

Ladder with 6 steps.  
Installation with Fixing Bar on the left door of the vehicle.  
Combines a Carry-Bike mounted on the right door.



### DELUXE DJ DUCATO H3

Ladder with 6 steps.  
Specific version for vehicles with height H3.

## CHOOSE THE MODEL THAT SUITS YOU

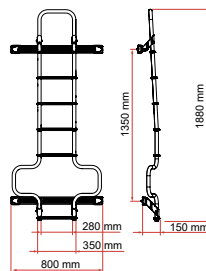

Deluxe DJ Ducato

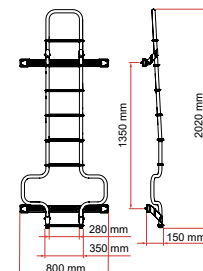

Deluxe DJ Ducato H3

	Deluxe DJ Ducato Deep Black	Deluxe DJ Ducato	Deluxe DJ Ducato H3 Deep Black	Deluxe DJ Ducato H3
Colour	Deep Black	Aluminium	Deep Black	Aluminium
Item No.	02426A09A	02426-09A	02426A17A	02426-17A
Weight	6,5kg	6,5kg	6,9kg	6,9kg
Number of steps	6	6	7	7
Compatible with	Carry-Bike Frame Ducato / Carry-Bike DJ Ducato	Carry-Bike Frame Ducato / Carry-Bike DJ Ducato	Carry-Bike Frame Ducato / Carry-Bike DJ Ducato	Carry-Bike Frame Ducato / Carry-Bike DJ Ducato







# Bi-Pot

SUITABLE FOR MOTORHOMES, CARAVANS AND VAN CONVERSIONS



Portable toilets and sanitary line designed for life in the open air.

## FEATURES:

- Scratch-resistant tanks
- Handy drain openings
- Easy to clean
- Comfortable and wide seat

## MODELS

### SMALL



### BI-POT 30

Upper tank capacity: 10L.  
Lower tank capacity: 11L.

### MEDIUM



### BI-POT 34

Upper tank capacity: 15L.  
Lower tank capacity: 13L.

### LARGE



### BI-POT 39

Upper tank capacity: 15L.  
Lower tank capacity: 20L.



### SUPER KEM BLUE

Detergent for fixed and portable toilets. It accelerates disintegration, limiting the formation of unpleasant gases and odours even at high temperatures. Eucalyptus fragrance. Concentrated version also available.



### SUPER KEM SACHETS

Powder disintegrating, deodorising and sanitising detergent. One container contains 15 sachets of Super Kem Sachets 30gr each. Eucalyptus fragrance.



### SUPER RINSE

For fresh water tanks of portable or fixed toilets. A perfumed liquid (eucalyptus) that prevents the build-up of limescale in the drainage tank; it ensures a complete and effective drainage, leaving no traces of dirt and optimising water consumption. Concentrated version also available.

### ☰ CHOOSE THE MODEL THAT SUITS YOU

	Weight	Upper Tank	Lower Tank	Dimensions	Colour	Item No.
Bi-Pot 30	3,9kg	10L	11L	43,5x34,5x30hcm	White	01356-01-
Bi-Pot 34	4,5kg	15L	13L	43,5x36x34hcm		01354-01-
Bi-Pot 39	4,6kg	15L	20L	43,5x36x39,2hcm		01355-01-
	Quantity	Item No.				
Super Kem Blue <b>[Restyling]</b>	2L	97310-028				
Super Kem Blue concentrated <b>[New]</b>	0,75L	97310-026				
Super Kem Sachets <b>[Restyling]</b>	15 sachets	97310-029				
Super Rinse <b>[Restyling]</b>	2L	97310-082				
Super Rinse concentrated <b>[New]</b>	0,75L	97310-081				



#### POCKET KASSETT

Composed of four storage pockets for storing Super Kem Sachets in powder and various materials. It is fixed with the standard screws inside the door of the Thetford or Dometic cassette of the vehicle.



#### DISPENSER

Soap or liquid shampoo dispenser (100 doses), 0.20L, with transparent container.



#### SOFT 6

Special two-ply toilet paper specially designed for fixed and portable toilets. Pack of 6 rolls, 300 sheets.



#### TOILET BRUSH

Equipped with Velcro to be applied also to the internal cover of the Bi-Pot.



#### BIDET

Universal bidet for all types of Bi-Pot. Thetford Porta Potti, Cassette 1, 2, 3 and 4. Bidet 200 for Thetford Cassette 200 swivelling, C250 and Dometic CT3000.



#### TOILET BRUSH PRO

Compact toilet brush holder for WC, takes up very little space in the corner of the bathroom.

### ☰ CHOOSE THE MODEL THAT SUITS YOU

	Soft 6	Pocket Kasset	Dispenser	Toilet Brush Pro	Toilet Brush	Bidet Universal	Bidet 200
Item No.	97312-010	06339-01-	04777-01-	98659-035	98659-025	03483-01-	03483A01-
Weight	0,7kg	0,2kg	0,2kg	0,2kg	0,1kg	0,3kg	0,3kg
Quantity	6 roll pack	-	0,2L	-	-	-	-

# Vehicle covers

SUITABLE FOR MOTORHOMES, CARAVANS AND VAN CONVERSIONS



When the journey comes to an end, Fiamma has the solution to protect your vehicle from the elements, dust, pollution and dirt, while waiting to set off on a new adventure.

## FEATURES:

- Perfect adherence to the vehicle
- Resistant material
- Different models for each type of vehicle

## MODELS



### COVER TOP

Made of UV-resistant fabric vinyl, easy to tension with ropes or elastic cords, reinforced corners and tie down grommets.

Dimensions: 8.5x5.2m.

Suitable for motorhomes, caravans and van conversions.



### THERMOGLAS XXL DUCATO

Designed for Fiat Ducato, Citroën Jumper and Peugeot Boxer ≥ 2006. Ideal for winter use to completely cover the engine compartment; insulated material suitable for low temperatures. Available in the complete model and "Windscreen" model with only the upper part.



### COVERGLAS

External blinds to protect the cab from the sun and UV rays, improved over previous models and with new light grey colour.

Available in 4 versions:

- Ducato: suitable for Fiat Ducato, Citroën Jumper and Peugeot Boxer ≥ 2006
- VW T5/T6
- Ford Transit H2 and H3 ≥ 2014
- Ford Transit Custom / Tourneo Custom > 2012



### THERMO WALL DUCATO CABIN

Convenient and useful thermal panel to be put between the cabin and the motorhome of Fiat Ducato, Citroën Jumper and Peugeot Boxer chassis after 06/2006, to grant more privacy and heat insulation. Dimensions: 182x150hcm .

## CHOOSE THE MODEL THAT SUITS YOU

	Weight	Item No.
Cover Top	6,0kg	04932-01-
Thermoglas XXL Ducato > 2006	11,0kg	06344A01-
Thermoglas Ducato Windscreen	5,0kg	08041-01-
Coverglas XL Ducato > 2006	3,5kg	08827-01-
Coverglas VW T5/T6	3,5kg	08827A01-
Coverglas Ford Transit	3,5kg	08827B01-
Coverglas Ford Transit Custom / Tourneo Custom > 2012	3,5kg	08827C01-
Thermo Wall Ducato Cabin	1,8kg	06585A01-



## COVER PREMIUM

Cover for the motorhome, with belt tension system for excellent adherence.

Available in two versions:

- M: for motorhomes up to 710cm.  
Dimensions:cm716 x 259 x 274 h
- L: for motorhomes up to 800cm.  
Dimensions:cm808 x 259 x 274 h

Suitable for both left- and right-hand drive motorhomes.



01 4 plastic buckles to fix the lower part



02 Maximum ventilation thanks to the air vents that also prevent condensation of water under the canopy



03 Velcro for fixing the side panels when they are fully open



04 6 convenient hinges (3 per side) allow entry into the vehicle on both sides



05 Locking system with sturdy plastic buckles. Reflective strips increase visibility during storage



### ☰ CHOOSE THE MODEL THAT SUITS YOU

	Dimensions	Weight	Item No.
Cover Premium M (up to 710cm)	cm716 x 259 x 274h	10,0kg	07916-01-
Cover Premium L (up to 800cm)	cm808 x 259 x 274h	11,0kg	07917-01-





# Various accessories

SUITABLE FOR MOTORHOMES, CARAVANS, VAN CONVERSIONS AND CAMPERVANS



To complete your Comfort range.

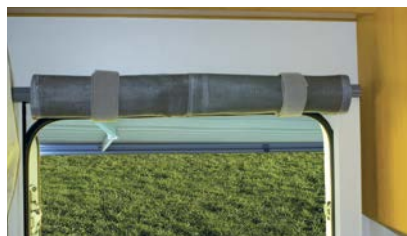

## MOSKITO NET

Mosquito net composed of 2 overlapping panels.  
Dimensions: 35x230cm.  
Maximum extension width: 64cm.



## MOSKITO NET PRO

Mosquito net which also acts as a shade panel blocking about 60% of the light. Composed of 2 overlapping panels.  
Dimensions: 52x230cm.  
Maximum extension width: 64cm.



## DRIP STOP

Mini-gutter to eliminate black streaks on your motorhome, caravan and vans. In the white and grey versions, the available sizes are 75, 300 and 1000cm. The black colour is available in lengths of 75, 200 and 500cm.



## DOOR HOLDER

External plastic door holder, to prevent unintentional closing.



## OMNI STOP

Multipurpose accessory to keep plates and items in place in the motorhome as you travel.



## TABLE LEGS

Modular table leg system, ideal to build removable and revolving tables.



## MUD FLAP

Rubber mud flaps with painted steel bracket.

**Mud Flap Front:** behind the front wheels of the Ducato after 2006.

**Mud Flap Rear:** installation in the rear panel of the motorhome.

### CHOOSE THE PRODUCT THAT SUITS YOU

	Weight	Item No.		Weight	Item No.
Moskito Net Pro	0,6kg	07485-01-	Omni Stop	0,1kg	04912-01-
Moskito Net	0,5kg	03508-01-	Mud Flap Front	1,2kg	06606-01-
Door Holder	0,1kg	04663-01A	Mud Flap Rear	1,2kg	06607-01-

	Weight	Item No. - White	Item No. - Grey	Item No. - Black
Drip Stop 75	0,2kg	03922-01-	03922-01G	03922-01A
Drip Stop 200	0,6kg	-	-	03922E01A
Drip Stop 300	0,8kg	03922A01-	03922A01G	-
Drip Stop 500	1,2kg	-	-	03922F01A
Drip Stop 1000	2,5kg	03922D01-	03922D01G	-



### HOW TO COMPOSE TABLE LEGS

	Weight	Item No.		Weight	Item No.
Tube Pro 70 (A)	0,7kg	06375A01-	Recessed Connection (D)	0,1kg	C0331-01-
Tripod Pro (B)	1,0kg	06362-01-	Cap (E)	0,1kg	02411-01B
Conic Connection (C)	0,2kg	C5063-01-	Adapter Tube Pro (F)	0,1kg	98655-605

- A Tube Pro 70**  
Painted aluminium table leg tube. Size 70cm, can be shortened, diameter 5.5cm
- B Tripod Pro**  
Reinforced tripod (PA)
- C Conic Connection**  
Conical connections in aluminium
- D Recessed Connection**  
Recessed conical connections in aluminium
- E Cap**  
Closure cap
- F Adapter Tube Pro**  
To store the Tube Pro





# Discover the best Fiamma accessories for you

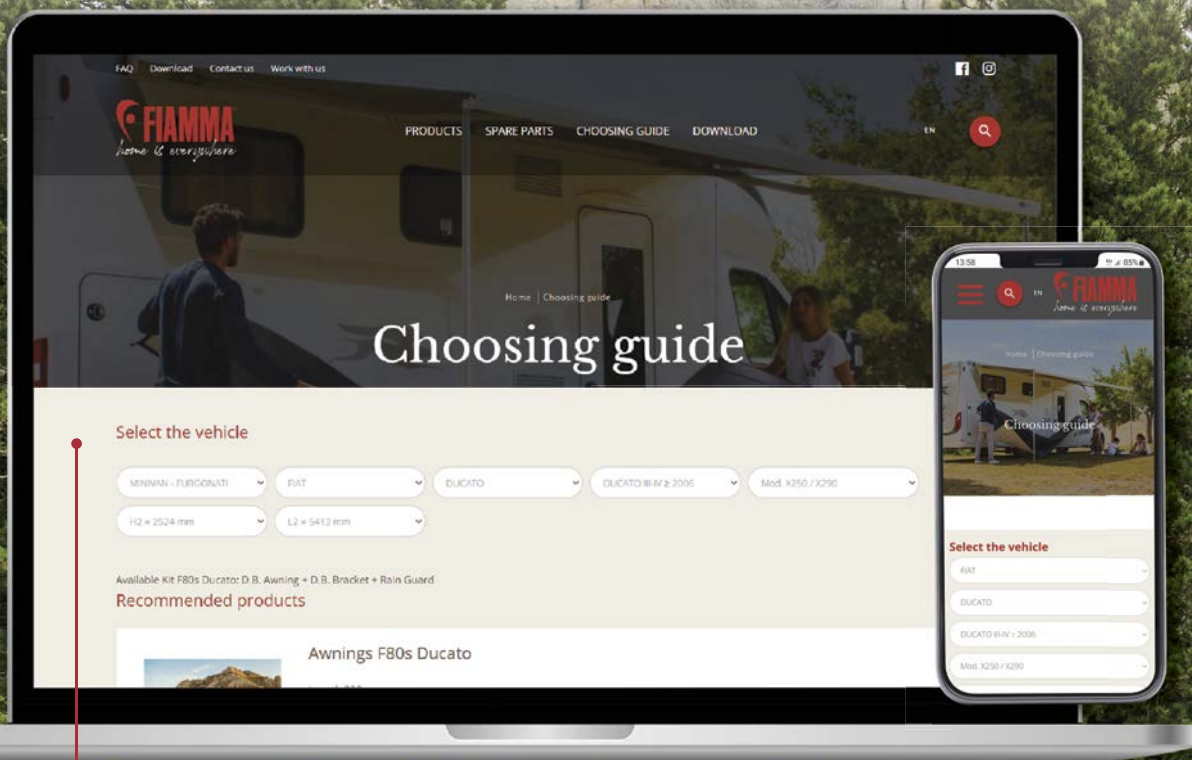

Go on [www.fiamma.com](http://www.fiamma.com) or scan the **Qrcode**

Click on **Choosing guide - Vehicles configurator** from the **Menu**

Fill in your vehicle **features** and discover which **Fiamma** products are good for you





# Video tutorial





FIAMMA STORE

Winch awnings for wall installation	
F43van	16-17
F45eagle	20-21
F45L	18-19
F45s	12-13
F45s minivan	14-15
Winch awnings for roof installation	
F65eagle	28-29
F40van	30-31
F80s	22-23
F80s Ducato	24-25
F80L	26-27
Manual awnings	
CaravanStore / XL	32-33
Compass	36-37
F35pro	34-35

Motor Kit	
Motor Kit	38-39
Awning accessories	
Crank Handle	43
Kit Awning Hangers	43
Kit Awning Pegs	43
Kit Awning Plate	43
Kit Cover	44-45
Kit Rain Guard	44-45
Kit Repair Plus	42-43
Magicrafter / Pro	40-41
Patio-Mat	42-43
Rafter / Pro	40-41
Rafter CaravanStore / XL	40-41
Rafter LED	172-175
Rafter LED CaravanStore	172-175
Rafter LED Van	172-175
Rain Guard	44-45

Safety Strip	42-43
Spoiler S	42-43
Telescopic Rafter Arm	40
Tie Down / S	42-43
Adapters	
Adapters CaravanStore	69
Adapters Compass	69
Adapters F35pro	65-68
Adapters F43van	54-57
Adapters F45	48-57
Adapters F40van	64-65
Adapters F80 - F65 - F65eagle	58-64
Side and Front panels	
Blocker / Pro	74-77
Shade Sun View	74-77
Side Block	78-81
Side W Pro	78-81

Side W Pro Shade	78-81
Side W Caravanstore	78-81
Sun View Side	78-81
Sun View XL	74-77
Enclosures	
Privacy Room	84-87
Privacy Room Light	88-91
Privacy Room CS Light	88-91
Privacy Ultra Light	92-93
Room Van Premium	94-95
Complete tents	
CaravanStore ZIP	96-97
Enclosure for roof	
Anti-condensation Mat for Moonlight Tent	99
Anti-theft Nuts Moonlight	99
Moonlight Tent	98-101
Privacy Moonlight Tent	99

Rear door enclosures	
Rear Door Cover	102
Skirting for wind protection	
Skirting	103
Enclosure accessories	
CaravanStore Support Legs	104-105
Curtains Kit Dark Grey	104-105
Door Pole	104-105
Kit Magic Privacy	104-105
Kit Poles	106-107
Kit Poles Light	106-107
Mega Bag Elite / Smart L	106-107
Mega Bag / Light	106-107
Pack Organizer Privacy	104-105
Patio-Bag	106-107
Patio-Mat / Light	106-107
Privacy Rail Kit	106-107
Rain Caps	104-105

CARRY-BIKE

Bike carriers for Motorhome	
CB Lift 77 / Motor Lift 77	118-119
CB Pro / Pro C	114-115
CB Pro C L80	120-121
CB Pro Autotrail	120-121
CB Pro Hymer - Dethleffs	120-121
CB Trigano - CI - Roller Team	120-121
CB UL / CL	116-117
Bike carriers for Caravan	
CB Caravan Active	122-123
CB Caravan Hobby	126-127
CB Caravan Universal	126-127
CB Caravan Simple Plus 200	126-127
CB Caravan XLA	122-123
CB Caravan XLA Pro 200	122-123
CB Caravan XLA Pro 300	122-123

Bike carriers for Campervan	
CB Ford Custom /Nugget Plus	136-137
CB Ford Custom V710	136-137
CB Ford Transit	136-137
CB Mercedes Viano	134-135
CB Mercedes Vito	134-135
CB Mercedes V Class / Lift E-Bike	134-135
CB Vivaro / Trafic / Talento	138-139
CB Vivaro / Trafic / Talento D	138-139
CB PSA	138-139
CB VW Caddy	130-131
CB VW T2	130-132
CB VW T3 (T25)	130-132
CB VW T4 / T4 D	130-132
CB VW T5 Pro / T6 Pro	128-129
CB VW T5 / T6	130-131

CB VW T5 D / T6 D	130-131
Bike carriers for Van conversion	
CB 200 D	146
CB 200 DJ Ducato	146
CB DJ Crafter	144-145
CB DJ Ducato	144-145
CB DJ Sprinter / Crafter	144-145
CB DJ Transit	144-145
CB Frame Crafter	140-143
CB Frame Ducato	140-143
CB Frame Sprinter	140-143
Bike carriers for SUV	
CB Backpack / 4x4	147
Bike carriers for garage	
CB Garage Plus	148-149
CB Garage Slide Pro Bike	148-149

CB Garage Standard	148-149
Carry-Moto / Pro	150-151
Carry-Ramp	150-151
Garage Plus/ Pack-Plus	148-149
Moto Wheel Chock Front/ Rear	150-151
Accessories for bike carriers	
Alu Signal	158-159
Bike Cover	158-159
Bike Frame Adapter	155
Bike-Block Pro S	154
Cable-Lock	155
Dust Guard	156
Easy Dry	158-159
Fixing-Bar Carry-Bike	156
Kit Dethleffs	121
Kit Premium S	152-153

Kit Rail Premium 48	152-153
Kit Rail Support Base Block	155
Kit Support Bar	156
Kit Upgrade E-Bike	152-153
Licence Plate Carrier	156
Plastic Signal	158-159
Quick-Safe	155
Rail Plus / XL	152-153
Rail Premium / S / XL / Fat Bike	152-153
Rail Quick Pro / C	152-153
Security Strip	155
Strip	155
Rear Boxes	
Cargo Back	157
Kit Frame Cargo Back	157
Ultra-Box 320-360-500	157

COMFORT

Rooflight without ventilator	
Vent	164-165
Vent F Pro	166
Vent 28 F	162-163
Vent 50	167
Rooflight with ventilator	
Turbo-Vent	164-165
Turbo-Vent Premium	164-165
Accessories rooflight	
Kit Frame Ducato 28 / 40	169
Kit Turbo Vent 28 F	163
Kit Turbo Vent F / Premium	166
Rollo Vent 40	170
Spoiler 40	170
Spoiler Universal	170
Thermo Vent 40	170
Turbo-Kit	168
Lighting	
Awning Arms LED	172-175
Kit Awning LED	172-175
Kit Cables Guide / Rail	172-175
Kit LED Awning Case 50	172-175
Kit LED Strip Awning	172-175
LED Awning Case	172-175
LED Awning Light	176-177

LED Awning Light Gutter	176-177
LED Garage Light	176-177
LED Sensor Door Light	176-177
LED Step	176-177
LED Warning Solar	176-177
Water	
A20	178
Aqua 8F	178
Kit Sanitary Flex	180-181
Quick Connection W	180-181
Roll-Tank	180-181
Tank 70	180-181
Cap	180-181
Level systems	
Alu Jacks	184
Anti Slip Plate	183
Chock Level	183
Clean Step	185
Grip System	184
Kit Level Up / Premium	182-183
Kit Level Up Premium S	182-183
Level Bag / S	182-183
Level Plate	182-183
Level Pro	182-183
Level System Magnum	182-183

Level System Jumbo	182-183
Level Up	182-183
Plastic Jacks	184
Plates / Plates Pro	184
Step / Step Magnum	185
Step-Mat	185
Wheel Saver	184
Organisation - Storage	
Carry-Dog	186-187
Fix Organizer	186-187
Pack Organizer	186-187
Pack Organizer Mix	186-187
Mega Bag Elite / Smart L	186-187
Mega Bag / Light	186-187
Pocket M / L / XL	188
Pocket Plus M / Plus L	188
Ultra-Box 2/3	189
Organisation - Roof	
Fixing-Bar Pro L	192
Fixing-Bar Rail	192
Kit Roof Rail Ducato Extra	190-191
Kit Roof Rail Ducato Cover	190-191
Roller Roof Rail	192
Roof Rail	192
Roof Rail Ducato	190-191

Organisation - Garage	
Cargo Strap	195
Garage Bars	193-194
Garage Box	193-194
Garage Carry-Rail	193-194
Garage System	193-194
Kit Cargo Accessory	195
Kit Eye / Eye Premium / Corner	195
Kit Garage Wall Brackets	193-194
Kit Square Plates	195
Luggage Bar	193-194
Safety	
Duo-Safe Pro	196-197
Kit Security Lock	198-199
Kit Spacer Safe Door	196-197
Safe Door / Frame	196-197
Safe Door Guardian	196-197
Safe Door Magnum / Frame	196-197
Security	198-199
Security Grip	198-199
Ladders	
Deluxe	200-201
Deluxe DJ	202
Deluxe Ducato	203

Safe Ladder	200-201
Hygiene	
Bidet	207
Bi-Pot	206
Dispenser	207
Pocket Kassett	207
Soft 6	207
Super Kem Blue / Concentrated	207
Super Kem Sachets	207
Super Rinse / Concentrated	207
Toilet Brush / Pro	207
Vehicle covers	
Cover Premium	208-209
Cover Top	208
Coverglas	208
Thermo Wall Ducato Cabin	208
Thermoglas XXL Ducato	208
Miscellaneous	
Door Holder	210
Drip Stop	210
Moskito Net / Pro	210
Mud Flap	210
Omni Stop	210
Table Legs	211



PRODUCTS ALPHABETIC INDEX

<b>A</b>	
A20	178
Adapters CaravanStore	69
Adapters Compass	69
Adapters F35pro	65-68
Adapters F43van	54-57
Adapters F45	48-57
Adapters F40van	64-65
Adapters F80 - F65 - F65eagle	58-64
Alu Jacks	184
Alu Signal	158-159
Anti-condensation Mat for Moonlight Tent	99
Anti Slip Plate	183
Anti-theft Nuts Moonlight	99
Aqua 8F	178
Awning Arms LED	172-175
<b>B</b>	
Bidet	207
Bike Cover	158-159
Bike Frame Adapter	155
Bike-Block Pro S	154
Bi-Pot	206
Blocker Pro / Blocker	74-77
<b>C</b>	
Cable-Lock	155
Cap	180-181
CaravanStore / XL	32-33
CaravanStore Support Legs	104-105
CaravanStore ZIP	96-97
Cargo Back	157
Cargo Strap	195
Carry-Bike 200 D / DJ Ducato < 2006	146
Carry-Bike DJ Crafter	144-145
Carry-Bike DJ Ducato	144-145
Carry-Bike DJ Sprinter / Crafter	144-145
Carry-Bike DJ Transit	144-145
Carry-Bike Backpack / 4x4	147
Carry-Bike Caravan Active	122-123
Carry-Bike Caravan Hobby	126-127
Carry-Bike Caravan Universal	126-127
Carry-Bike Caravan XL A	122-123
Carry-Bike Caravan XL A Pro 200	122-123
Carry-Bike Caravan XL A Pro 300	122-123
Carry-Bike Frame Ducato	140-143
Carry-Bike Frame VW Crafter	140-143
Carry-Bike Frame Sprinter	140-143
Carry-Bike Ford Custom / Nugget Plus	136-137
Carry-Bike Ford Custom V710	136-137
Carry-Bike Ford Transit	136-137
Carry-Bike Garage Plus	148-149
Carry-Bike Garage Slide Pro Bike	148-149
Carry-Bike Garage Standard	148-149
Carry-Bike Pro C L80	120-121
Carry-Bike Lift 77 / Motor Lift 77	118-119
Carry-Bike Mercedes Viano	134-135
Carry-Bike Mercedes Vito	135-135
Carry-Bike Mercedes V Class / Lift E-Bike	134-135
Carry-Bike Vivaro - Traffic - Talento / D	138-139
Carry-Bike Pro / Pro C	114-115
Carry-Bike Pro Autotrail	120-121
Carry-Bike Pro Hymer - Dethleffs	120-121
Carry-Bike PSA	138-139
Carry-Bike Simple Plus 200	126-127
Carry-Bike Trigano - Cl - Roller Team	120-121

Carry-Bike UL / CL	116-117
Carry-Bike VW Caddy	130-131
Carry-Bike VW T2	130-132
Carry-Bike VW T3 (T25)	130-132
Carry-Bike VW T4 / T4 D	130-132
Carry-Bike VW T5 Pro / T6 Pro	128-129
Carry-Bike VW T5 / T6	130-131
Carry-Bike VW T5 D / T6 D	130-131
Carry-Dog	186-187
Carry-Moto / Pro	150-151
Carry-Ramp	150-151
Chock Level	183
Clean Step	185
Compass	36-37
Cover Premium	208-209
Cover Top	208
Coverglas	208
Crank Handle	43
Curtains Kit Dark Grey	104-105
<b>D</b>	
Deluxe	200-201
Deluxe DJ	202
Deluxe Ducato	203
Dispenser	207
Door Holder	210
Door Pole	104-105
Drip Stop	210
Duo-Safe Pro	196-197
Dust Guard	156
<b>E</b>	
Easy Dry	158-159
<b>F</b>	
F35pro	34-35
F40van	30-31
F45eagle	20-21
F45L	18-19
F45s	12-13
F43van	16-17
F45s minivan	14-15
F65eagle	28-29
F80s	22-23
F80s Ducato	24-25
F80L	26-27
Fix Organizer	186-187
Fixing-Bar Carry-Bike	156
Fixing-Bar Pro L	192
Fixing-Bar Rail	192
<b>G</b>	
Garage Bars	193-194
Garage Box	193-194
Garage Carry-Rail	193-194
Garage Pack-Plus	148-149
Garage System	193-194
Grip System	184
<b>K</b>	
Kit Awning Hangers	43
Kit Awning LED	172-175
Kit Awning Pegs	43
Kit Awning Plate	43
Kit Cables Guide / Rail	172-175
Kit Cargo Accessory	195
Kit Cover	44-45
Kit Dethleffs	121
Kit Eye / Eye Premium / Corner	195
Kit Frame Cargo Back	157

Kit Frame Ducato 28 / 40	169
Kit Garage Wall Brackets	193-194
Kit LED Awning Case 50	172-175
Kit LED Strip Awning	172-175
Kit Level Up / Premium / Premium S	182-183
Kit Magic Privacy	104-105
Kit Poles / Light	106-107
Kit Premium S	152-153
Kit Rail Premium 48	152-153
Kit Rail Support Base Block	155
Kit Rain Guard	44-45
Kit Repair Plus	42-43
Kit Roof Rail Ducato Extra	190-191
Kit Roof Rail Ducato Cover	190-191
Kit Sanitary Flex	180-181
Kit Security Lock	198-199
Kit Spacer Safe Door	196-197
Kit Square Plates	195
Kit Support Bar	156
Kit Turbo Vent 28 F	163
Kit Turbo Vent F / Premium	166
Kit Upgrade E-Bike	152-153
<b>L</b>	
LED Awning Case	172-175
LED Awning Light	176-177
LED Awning Light Gutter	176-177
LED Garage Light	176-177
LED Sensor Door Light	176-177
LED Step	176-177
LED Warning Solar	176-177
Level Bag / S	182-183
Level Plate	182-183
Level Pro	182-183
Level System Magnum	182-183
Level System Jumbo	182-183
Level Up	182-183
Licence Plate Carrier	156
Luggage Bar	193-194
<b>M</b>	
Magicrofter / Pro	40-41
Mega Bag Elite / Smart L	186-187
Mega Bag / Light	186-187
Moskito Net / Pro	210
Moto Wheel Chock Front/Rear	150-151
Motor Kit	38-39
Moonlight Tent	98-101
Mud Flap	210
<b>O</b>	
Omni Stop	210
<b>P</b>	
Pack Organizer	186-187
Patio-Bag	106-107
Patio-Mat / Light	106-107
Plastic Jacks	184
Plastic Signal	158-159
Plates / Plates Pro	184
Pocket Kassett	207
Pocket M / L / XL / Plus M / Plus L	188
Privacy Rail Kit	106-107
Privacy Room	84-87
Privacy Room Light / CS Light	88-91
Privacy Moonlight Tent	99
Privacy Ultra Light	92-93
<b>Q</b>	
Quick Connection W	180-181

Quick-Safe	155
<b>R</b>	
Rafter / Rafter Pro	40
Rafter CaravanStore / XL	41
Rafter LED	172-175
Rafter LED CaravanStore	172-175
Rafter LED Van	172-175
Rail Plus / XL	152-153
Rail Premium / S / XL / Fat Bike	152-153
Rail Quick Pro / C	152-153
Rain Caps	104-105
Rain Guard	44-45
Rear Door Cover	102
Roller Roof Rail	192
Rollo Vent 40	170
Roll-Tank	180-181
Room Van Premium	94-95
Roof Rail	192
Roof Rail Ducato	190-191
<b>S</b>	
Safe Door / Frame / Magnum	196-197
Safe Door Guardian	196-197
Safety Strip	42-43
Safe Ladder	200-201
Security	198-199
Security Grip	198-199
Security Strip	155
Shade Sun View	74-77
Side Block	78-81
Side W Pro / Shade	78-81
Side W Caravanstore	78-81
Skirting	103
Soft 6	207
Spoiler 40 / Spoiler Universal	170
Spoiler S	42-43
Step / Step Magnum	185
Step-Mat	185
Strip	155
Super Kem Blue / Concentrated	207
Super Kem Blue Sachets	207
Super Rinse / Concentrated	207
Sun View Side	78-79
Sun View XL	74-77
<b>T</b>	
Table Legs	211
Tank 70	180-181
Telescopic Rafter Arm	40
Thermo Vent 40	170
Thermo Wall Ducato Cabin	208
Thermoglas XXL Ducato	208
Tie Down / Tie Down S	42-43
Toilet Brush / Pro	207
Turbo-Kit	168
Turbo-Vent	164-165
Turbo-Vent Premium	164-165
<b>U</b>	
Ultra-Box 2/3	189
Ultra-Box 320-360-500	157
<b>V</b>	
Vent	164-154
Vent F Pro	166
Vent 28 F	162-163
Vent 50	167
<b>W</b>	
Wheel Saver	184



**Fiamma SpA - Italy**  
Via S. Rocco, 56 - 21010 Cardano al Campo (VA)